

SKRZYNKI ALUMINIOWE I AKCESORIA  
ALUMINIUMKÄSTEN UND ZUBEHÖR  
ALUMINIUM SHUTTER BOXES AND ACCESSORIES  
HLINÍKOVÉ BOXY A PŘÍSLUŠENSTVÍ

# KODY KOLORÓW

## DIE FARBCODES

## COLOR CODES

## KÓDY BAREV

<b>x</b>	<b>Kolor   Farbe   Colour   Barva</b>
00	nielakierowany   unlackiert   mill finish   nelakovaná
01	srebrny   silber   silver   stříbrná
02	biały   weiß   white   bílá
03	szary   grau   grey   šedá
05	beżowy   beige   beige   béžová
08	ciemnobrązowy   dunkelbraun   dark brown   tmavě hnědá
09	brązowy   braun   brown   hnědá
15	biel kremowa   cremeweiß   cream white   bílá krémová
22	ultra biały   ultraweiß   ultra white   ultra bílá
23	szary antracyt   anthrazitgrau   anthracite grey   antracitová šedá
26	mahoń   mahagoni   mahogany   mahagon
28	orzech   nuss   nut   ořech
30	złoty dąb   goldeiche   golden oak   zlatý dub
32	karmel   karamel   caramel   karamel
34	kvarcowy szary   quarzgrau   quartz grey   křemenná šedá
40	biały, perłowy mat   weiß, perlmutt matt   white, pearl mat   bílá, perlový mat
41	jasny szary, perłowy mat   hellgrau, perlmutt matt   light grey, pearl mat   světle šedá, perlový mat
42	szary, perłowy mat   grau, perlmutt matt   grey, pearl mat   šedá, perlový mat
43	szary antracyt, perłowy mat   anthrazitgrau, perlmutt matt   anthracite grey, pearl mat   antracitová šedá, perlový mat
44	ciemny szary, perłowy mat   dunkelgrau, perlmutt matt   dark grey, pearl mat   tmavě šedá, perlový mat
52	winchester   Winchester   winchester   winchester
53	dąb ciemny   dunkel Eiche   dark oak   tmavý dub
99	lakier podkładowy   Unterschicht-Lack   primer   podkladový lak

# KODY ELEMENTÓW

## CODES DER ELEMENTEN

## CODES OF ELEMENTS

## KÓDY PRVKŮ

Skrzynki roletowe i akcesoria | Rollkasten und Zubehör | Roller shutter boxes and accessories | Roletové boxy a příslušenství

	00	01	02	03	05	08	09	15	22	23	26	28	30	32	34	40	41	42	43	44	52	53	
<b>SK / G</b>		x	x	x	x	x	x	x	x	x	x	x	x	R	x								
<b>SK 45 / D</b>		x	x	x	x	x	x	x	x	x	x	x	x	R	x								
<b>SKE 45 / G</b>	x	x	x	x	x	x	x			x													
<b>SKE 45 / D</b>	x	x	x	x	x	x	x			x													
<b>SKE 45 / T</b>	x	x	x	x	x	x	x			x													
<b>SKP / D</b>		x	x	x		x	x			x													
<b>SKO-P / G</b>		x	x	x		x	x	x	x	x					x								
<b>SKO-P / D</b>		x	x	x		x	x	x	x	x					x								
<b>SKO / G</b>	x	x	x	x		x	x		x	x						S	S	S	S	S			
<b>SKO / D</b>	x	x	x	x		x	x		x	x						S	S	S	S	S			
<b>SKO / T</b>	x	x	x	x		x	x		x	x						S	S	S	S	S			
<b>SP 90 SK-E</b>	x																						
<b>SP 90 PR-E</b>	x	x	x	x		x	x		x	x		R	R			S	S	S	S	S	R	R	
<b>SP 90 WPR-E</b>	x	x	x	x		x	x		x	x		R	R			S	S	S	S	S	R	R	
<b>SP 90 PZ</b>	x	x	x	x		x	x			x		R	R			S	S	S	S	S			
<b>SP 90 PR</b>	x	x	x	x		x	x			x		R	R			S	S	S	S	S			
<b>SPS 90</b>	x	x	x	x		x	x			x		R	R			S	S	S	S	S			
<b>KT 30</b>	x	x	x	x	x	x	x		x	x													
<b>SPZ 90</b>			x			x	x			x					x								
<b>SPD 90</b>			x	x		x	x			x					x								
<b>BS 45</b>	x	x	x	x	x	x	x	x	x	x	R	x	x	x									
<b>BS_45</b>	x	x	x	x	x	x	x	x	x	x	R	x	x	x	x								
<b>BSW 45</b>	x																						
<b>BSW_45</b>	x																						
<b>BSWZ 45</b>	x																						
<b>BSWZ_45</b>	x																						
<b>BSWN 45</b>	x																						
<b>BSWN_45</b>	x																						
<b>BSP</b>	x	x	x	x		x	x			x													
<b>BSPW</b>	x																						
<b>BSPWZ</b>	x																						
<b>BSPWN</b>	x																						
<b>BSO</b>	x	x	x	x		x	x	x	x	x					x	S	S	S	S	S			
<b>BOW</b>	x																						
<b>BOWZ</b>	x																						
<b>BOWN</b>	x																						
<b>BS 90</b>	x																						
<b>BSW 90</b>	x																						
<b>BSWZ 90</b>	x																						

R - Oklejane folią dekoracyjną | mit Dekorfolie furniert | Decorative foil | Polep dekorativní folií

S - Oklejane folią dekoracyjną | mit Dekorfolie furniert | Decorative foil | Polep dekorativní folií

	00	01	02	03	08	09	23	28	30	99
<b>SK / G</b>		×	×	×	×	×	×	×	×	
<b>SK 45 / D</b>		×	×	×	×	×	×	×	×	
<b>SK / G / 350</b>		×	×	×	×	×				
<b>SK / T / 350</b>		×	×	×	×	×				
<b>SKO-P / G</b>			×							×
<b>SKO-P / D</b>			×							×
<b>BS 45</b>	×	×	×	×	×	×	×	×	×	
<b>BS 45 / K / 350</b>	×	×	×	×	×	×	×			
<b>BSO</b>	×		×							

**NOWE PRODUKTY**  
**NEUE PRODUKTE**  
**NEW PRODUCTS**  
**NOVÉ VÝROBKY**

<b>SK / G</b>	Skrzynka roletowa - góra Rollladenkasten - Oberteil Shutter box - top Roletový box - horní strana	SK/G/137/34 SK/G/150/30 SK/G/165/34 SK/G/180/34 SK/G/205/34
<b>SK 45 / D</b>	Skrzynka roletowa 45° - dół Rollladenkasten 45° - Unterteil Shutter box 45° - base Roletový box 45° - spodní strana	SK45/D/137/34 SK45/D/150/30 SK45/D/165/34 SK45/D/180/34 SK45/D/205/34
<b>SKE 45 / G</b>	Skrzynka roletowa ekstrudowana 45° - góra Extrudierter Rollladenkasten 45° - Oberteil Extruded shutter box 45° - top Extrudovaný roletový box 45° - horní strana	SKE45/G/137/x SKE45/G/165/x SKE45/G/180/x SKE45/G/205/x
<b>SKE 45 / D</b>	Skrzynka roletowa ekstrudowana 45° - dół Extrudierter Rollladenkasten 45° - Unterteil Extruded shutter box 45° - base Extrudovaný roletový box 45° - spodní strana	SKE45/D/137/x SKE45/D/165/x SKE45/D/180/x SKE45/D/205/x SKE45/D/MKT/165/x SKE45/D/MKT/180/x
<b>SKE 45 / T</b>	Skrzynka roletowa ekstrudowana 45° - tył Extrudierter Rollladenkasten 45° - Rückblende Extruded shutter box 45° - back part Extrudovaný roletový box 45° - zadní strana	SKE45/T/137/x SKE45/T/165/x SKE45/T/180/x SKE45/T/205/x
<b>SKP / D</b>	Skrzynka roletowa - dół Rollladenkasten - Unterteil Shutter box - base Roletový box - spodní strana	SKP/D/137/23 SKP/D/165/23 SKP/D/180/23
<b>SKO-P / G</b>	Skrzynka roletowa systemu Owal - góra Rollladenkasten des OWAL-Systems – Oberteil Shutter box Owal - top Roletový box systému OWAL - horní strana	SKO-P/G/137/15 SKO-P/G/137/22 SKO-P/G/137/34 SKO-P/G/165/15 SKO-P/G/165/22 SKO-P/G/165/34 SKO-P/G/180/15 SKO-P/G/180/22 SKO-P/G/180/34 SKO-P/G/205/15 SKO-P/G/205/34
<b>SKO-P / D</b>	Skrzynka roletowa systemu Owal - dół Rollladenkasten des OWAL-Systems - Unterteil Shutter box Owal system - base Roletový box systému OWAL - spodní strana	SKO-P/D/137/15 SKO-P/D/137/22 SKO-P/D/137/34 SKO-P/D/165/15 SKO-P/D/165/22 SKO-P/D/165/34 SKO-P/D/180/15 SKO-P/D/180/22 SKO-P/D/180/34 SKO-P/D/205/15 SKO-P/D/205/34

<b>SP 90 PR-E</b>	Pokrywa rewizyjna skrzynki podtynkowej SP-E Revisionsklappe für Unterputzkasten SP-E Flap for under plaster shutter box SP-E Revizní kryt boxu pod omítkou SP-E	SP90PR-E/137/22 SP90PR-E/150/22 SP90PR-E/165/22 SP90PR-E/180/22 SP90PR-E/205/22 SP90PR-E/MKT/205/22
<b>SP 90 WPR-E</b>	Wspornik pokrywy rewizyjnej skrzynki podtynkowej SP-E Kragarm für Revisionsklappe des Unterputzkastens SP-E Bracket of flap for under plaster shutter box SP-E Vzpěra revizního krytu boxu pod omítkou SP-E	SP90WPR-E/15/22 SP90WPR-E/30/22
<b>KT 30</b>	Kątownik aluminiowy Aluminium-Winkel Aluminium angle Hliníkový úhelník	KT30/22
<b>TR/25x13</b>	Taśma rozprężna Ausdehnungsband Expansion tape Expanzní páska	TR/25x13
<b>BS 45</b>	Pokrywa boczna skrzynki 45° - stopka typ I Blendenkappen 45° - Bolzen Typ I End cap 45° - pin type I Boční kryt boxu 45° - patka typu I	BS45/150/30
<b>BS_45</b>	Pokrywa boczna skrzynki 45° - stopka typ I Blendenkappen 45° - Bolzen Typ I End cap 45° - pin type I Boční kryt boxu 45° - patka typu I	BS_45/137/x BS_45/165/x BS_45/180/x BS_45/205/x
<b>BSW_45</b>	Bok skrzynki 45° wewnętrzny - stopka typ I Innenblendenkappen 45° - Bolzen Typ I Internal end cap 45° - pin type I Bok boxu 45° wnitřní - patka typu I	BSW_45/137/x BSW_45/165/x BSW_45/180/x BSW_45/205/x
<b>BSWZ_45</b>	Boki skrzynki 45° wewnętrzne, zespolone - stopka typ I Zusammengesetzte Innenblendenkappen 45° - Bolzen Typ I Compound internal end caps 45° - pin type I Boky boxu 45° wnitřně spojené - patka typu I	BSWZ_45/137/x BSWZ_45/165/x BSWZ_45/180/x BSWZ_45/205/x
<b>BSWN_45</b>	Bok skrzynki 45° wewnętrzny, wspólny napęd - stopka typ I Innenblendenkappen 45°, gemeinsamer Antrieb - Bolzen Typ I Internal end cap 45°, common drive - pin type I Bok boxu 45° wnitřní, společný pohon - patka typu I	BSWN_45/165/x BSWN_45/180/x BSWN_45/205/x
<b>BSP</b>	Pokrywa boczna skrzynki - stopka typ I Blendenkappen - Bolzen Typ I End cap - pin type I Boční kryt boxu - patka typu I	BSP/137/23 BSP/165/23 BSP/180/23
<b>BSO</b>	Pokrywa boczna skrzynki owalnej - stopka typ I Rund-Blendenkappen - Bolzen Typ I Round end cap - pin type I Boční kryt oválného boxu - patka typu I	BSO/137/15 BSO/137/22 BSO/137/34 BSO/165/15 BSO/165/22 BSO/165/34 BSO/180/15 BSO/180/22 BSO/180/34 BSO/205/15 BSO/205/22 BSO/205/34
<b>SK / G</b>	Skrzynka bramowa - góra Garagentorkasten - Oberteil Shutter box for gates - top Box vrat - horní strana	SK/G/300/28 SK/G/300/30
<b>SK 45 / D</b>	Skrzynka bramowa 45° - dół Garagentorkasten 45° - Unterteil Shutter box for gates 45° - base Box vrat 45° - spodní strana	SK45/D/300/28 SK45/D/300/30
<b>BS 45</b>	Pokrywa boczna skrzynki 45° - stopka typ II Blendenkappen 45° - Bolzen Typ II End cap 45° - pin type II Boční kryt boxu 45° - patka typu II	BS45/300/28 BS45/300/30

# SK / G

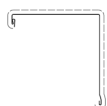
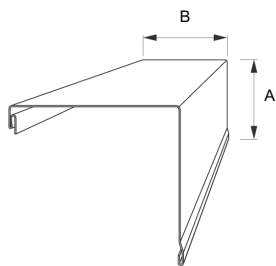

oklejane folią dekoracyjną  
mit Dekorfolie beklebt  
covered with a decorative foil  
polepeno dekorativní fólií

**Skrzynka roletowa - góra**  
**Rollladenkasten - Oberteil**  
**Shutter box - top**  
**Roletový box - horní strana**

Pakowanie: szt. x m | Packung: St. x m | Packing: pcs. x m | Balení: ks x m

	A	B	
<b>SK/G/125/x</b>	128	125	5x6
<b>SK/G/137/x</b>	139	137	5x6
<b>SK/G/150/x</b>	153	150	5x6
<b>SK/G/165/x</b>	167	165	5x6
<b>SK/G/180/x</b>	183	180	5x6
<b>SK/G/205/x</b>	207	205	5x6

x	Kolor   Farbe   Colour   Barva
<b>01</b>	srebrny   silber   silver   stříbrná
<b>02</b>	biały   weiß   white   bílá
<b>03</b>	szary   grau   grey   šedá
<b>05</b>	beżowy   beige   beige   béžová
<b>08</b>	ciemnobrązowy   dunkelbraun   dark brown   tmavě hnědá
<b>09</b>	brązowy   braun   brown   hnědá
<b>15</b>	biel kremowa   cremeweiß   cream white   bílá krémová
<b>22</b>	ultra biały   ultraweiß   ultra white   ultra bílá
<b>23</b>	szary antracyt   anthrazitgrau   anthracite grey   antracitová šedá
<b>26</b>	mahoń   mahagoni   mahogany   mahagon
<b>28</b>	orzech   nuss   nut   ořech
<b>NEW 30</b>	złoty dąb   goldeiche   golden oak   zlatý dub
<b>30R</b>	złoty dąb   goldeiche   golden oak   zlatý dub
<b>NEW 34</b>	kwarcowy szary   quarzgrau   quartz grey   křemenná šedá

R - Oklejane folią dekoracyjną | mit Dekorfolie furniert | Decorative foil | Polep dekorativní fólií

	01	02	03	05	08	09	15	22	23	26	28	30	30R	34
<b>SK/G/125/x</b>		x	x		x	x		x	x					
<b>SK/G/137/x</b>	x	x	x	x	x	x	x	x	x	x	x	x	x	+
<b>SK/G/150/x</b>	x	x	x	x	x	x	x	x	x			+	x	
<b>SK/G/165/x</b>	x	x	x	x	x	x	x	x	x	x	x	x	x	+
<b>SK/G/180/x</b>	x	x	x	x	x	x	x	x	x	x	x	x	x	+
<b>SK/G/205/x</b>	x	x	x	x	x	x			x		x	x	x	+

R - Oklejane folią dekoracyjną | mit Dekorfolie furniert | Decorative foil | Polep dekorativní fólií

Systemy SK / SAR / SKP / SP

## SK 45 / D

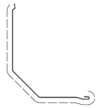
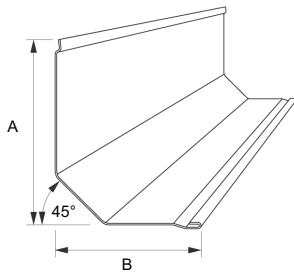

oklejane folią dekoracyjną  
mit Dekorfolie beklebt  
covered with a decorative foil  
polepeno dekorativní fólií

**Skrzynka roletowa 45° - dół**  
**Rollladenkasten 45° - Unterteil**  
**Shutter box 45° - base**  
**Roletový box 45° - spodní strana**

Pakowanie: szt. x m | Packung: St. x m | Packing: pcs. x m | Balení: ks x m

	A	B	
<b>SK45/D/125/x</b>	115	90	5x6
<b>SK45/D/137/x</b>	127	104	5x6
<b>SK45/D/150/x</b>	140	114	5x6
<b>SK45/D/165/x</b>	155	130	5x6
<b>SK45/D/180/x</b>	170	144	5x6
<b>SK45/D/205/x</b>	195	170	5x6
<b>SK45/D/MKT/150/x</b>	140	104	1x6
<b>SK45/D/MKT/165/x</b>	155	119	1x6
<b>SK45/D/MKT/180/x</b>	170	133	1x6
<b>SK45/D/MKT/205/x</b>	195	158	1x6

x	Kolor   Farbe   Colour   Barva
<b>01</b>	srebrny   silber   silver   stříbrná
<b>02</b>	biały   weiß   white   bílá
<b>03</b>	szary   grau   grey   šedá
<b>05</b>	beżowy   beige   beige   béžová
<b>08</b>	ciemnobrązowy   dunkelbraun   dark brown   tmavě hnědá
<b>09</b>	brązowy   braun   brown   hnědá
<b>15</b>	biel kremowa   cremeweiß   cream white   bílá krémová
<b>22</b>	ultra biały   ultraweiß   ultra white   ultra bílá
<b>23</b>	szary antracyt   anthrazitgrau   anthracite grey   antracitová šedá
<b>26</b>	mahoń   mahagoni   mahogany   mahagon
<b>28</b>	orzech   nuss   nut   ořech
<b>NEW 30</b>	złoty dąb   goldeiche   golden oak   zlatý dub
<b>30R</b>	złoty dąb   goldeiche   golden oak   zlatý dub
<b>NEW 34</b>	kwarcowy szary   quarzgrau   quartz grey   křemenná šedá

R - Oklejane folią dekoracyjną | mit Dekorfolie furniert | Decorative foil | Polep dekorativní fólií

	01	02	03	05	08	09	15	22	23	26	28	30	30R	34
<b>SK45/D/125/x</b>		x	x		x	x		x	x					
<b>SK45/D/137/x</b>	x	x	x	x	x	x	x	x	x	x	x	x	x	+
<b>SK45/D/150/x</b>	x	x	x	x	x	x	x	x	x			+	x	
<b>SK45/D/165/x</b>	x	x	x	x	x	x	x	x	x	x	x	x	x	+
<b>SK45/D/180/x</b>	x	x	x	x	x	x	x	x	x	x	x	x	x	+
<b>SK45/D/205/x</b>	x	x	x	x	x	x			x		x	x	x	+
<b>SK45/D/MKT/150/x</b>	x	x	x	x	x	x	x	x	x					
<b>SK45/D/MKT/165/x</b>	x	x	x	x	x	x	x	x	x	x	x	x	x	
<b>SK45/D/MKT/180/x</b>	x	x	x	x	x	x	x	x	x	x	x	x	x	
<b>SK45/D/MKT/205/x</b>	x	x	x	x	x	x			x		x	x	x	

R - Oklejane folią dekoracyjną | mit Dekorfolie furniert | Decorative foil | Polep dekorativní fólií

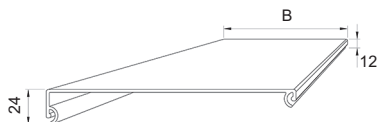
**SKE 45 / G****NEW****Skrzynka roletowa ekstrudowana 45° - góra****Extrudierter Rollladenkasten 45° - Oberteil****Extruded shutter box 45° - top****Extrudovaný roletový box 45° - horní strana**

Pakowanie: szt. x m | Packung: St. x m | Packing: pcs. x m | Balení: ks x m

	<b>B</b>	
<b>SKE45/G/137/x</b>	138	5x6
<b>SKE45/G/165/x</b>	167	5x6
<b>SKE45/G/180/x</b>	182	5x6
<b>SKE45/G/205/x</b>	205	5x6

<b>x</b>	<b>Kolor   Farbe   Colour   Barva</b>
<b>00</b>	nie lakierowany   unlackiert   mill finish   nelakovaná
<b>01</b>	srebrny   silber   silver   stříbrná
<b>02</b>	biały   weiß   white   bílá
<b>03</b>	szary   grau   grey   šedá
<b>05</b>	beżowy   beige   beige   béžová
<b>08</b>	ciemnobrązowy   dunkelbraun   dark brown   tmavě hnědá
<b>09</b>	brązowy   braun   brown   hnědá
<b>23</b>	szary antracyt   anthrazitgrau   anthracite grey   antracitová šedá

## Systemy SKE / SAR

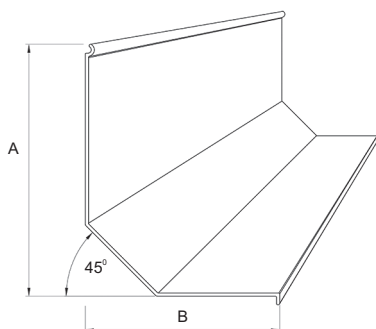
**SKE 45 / D****NEW****Skrzynka roletowa ekstrudowana 45° - dół****Extrudierter Rollladenkasten 45° - Unterteil****Extruded shutter box 45° - base****Extrudovaný roletový box 45° - spodní strana**

Pakowanie: szt. x m | Packung: St. x m | Packing: pcs. x m | Balení: ks x m

	<b>A</b>	<b>B</b>	
<b>SKE45/D/137/x</b>	119	105	5x6
<b>SKE45/D/165/x</b>	148	130	5x6
<b>SKE45/D/180/x</b>	163	145	5x6
<b>SKE45/D/205/x</b>	188	164	5x6
<b>SKE45/D/MKT/165/x</b>	148	123	5x6
<b>SKE45/D/MKT/180/x</b>	163	138	5x6

<b>x</b>	<b>Kolor   Farbe   Colour   Barva</b>
<b>00</b>	nie lakierowany   unlackiert   mill finish   nelakovaná
<b>01</b>	srebrny   silber   silver   stříbrná
<b>02</b>	biały   weiß   white   bílá
<b>03</b>	szary   grau   grey   šedá
<b>05</b>	beżowy   beige   beige   béžová
<b>08</b>	ciemnobrązowy   dunkelbraun   dark brown   tmavě hnědá
<b>09</b>	brązowy   braun   brown   hnědá
<b>23</b>	szary antracyt   anthrazitgrau   anthracite grey   antracitová šedá

## Systemy SKE / SAR

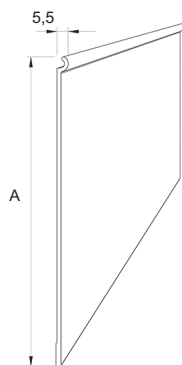

## SKE 45 / T

**NEW**

**Skrzynka roletowa ekstrudowana 45° - tył**  
**Extrudierter Rollladenkasten 45° - Rückblende**  
**Extruded shutter box 45° - back part**  
**Extrudovaný roletový box 45° - zadní strana**

Pakowanie: szt. x m | Packung: St. x m | Packing: pcs. x m | Balení: ks x m

	A	
<b>SKE45/T/137/x</b>	130	5x6
<b>SKE45/T/165/x</b>	160	5x6
<b>SKE45/T/180/x</b>	175	5x6
<b>SKE45/T/205/x</b>	200	5x6

x	Kolor   Farbe   Colour   Barva
<b>00</b>	nie lakierowany   unlackiert   mill finish   nelakovaná
<b>01</b>	srebrny   silber   silver   stříbrná
<b>02</b>	biały   weiß   white   bílá
<b>03</b>	szary   grau   grey   šedá
<b>05</b>	beżowy   beige   beige   béžová
<b>08</b>	ciemnobrązowy   dunkelbraun   dark brown   tmavě hnědá
<b>09</b>	brązowy   braun   brown   hnědá
<b>23</b>	szary antracyt   anthrazitgrau   anthracite grey   antracitová šedá

### Systemy SKE / SAR / SKEF

## SKP / D

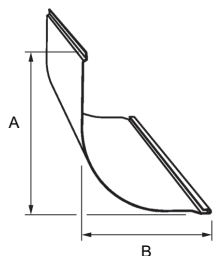

**Skrzynka roletowa - dół**  
**Rollladenkasten - Unterteil**  
**Shutter box - base**  
**Roletový box - spodní strana**

Pakowanie: szt. x m | Packung: St. x m | Packing: pcs. x m | Balení: ks x m

	A	B	
<b>SKP/D/137/x</b>	129	105	5x6
<b>SKP/D/150/x</b>	142	115	5x6
<b>SKP/D/165/x</b>	157	128	5x6
<b>SKP/D/180/x</b>	172	143	5x6
<b>SKP/D/205/x</b>	197	160	5x6
<b>SKP/D/MKT/150/x</b>	142	101	5x6
<b>SKP/D/MKT/165/x</b>	157	121	5x6
<b>SKP/D/MKT/180/x</b>	172	136	5x6

x	Kolor   Farbe   Colour   Barva
<b>01</b>	srebrny   silber   silver   stříbrná
<b>02</b>	biały   weiß   white   bílá
<b>03</b>	szary   grau   grey   šedá
<b>08</b>	ciemnobrązowy   dunkelbraun   dark brown   tmavě hnědá
<b>09</b>	brązowy   braun   brown   hnědá
<b>NEW 23</b>	szary antracyt   anthrazitgrau   anthracite grey   antracitová šedá

	01	02	03	08	09	23
<b>SKP/D/137/x</b>	x	x	x	x	x	+
<b>SKP/D/150/x</b>	x	x	x	x	x	
<b>SKP/D/165/x</b>	x	x	x	x	x	+
<b>SKP/D/180/x</b>	x	x	x	x	x	+
<b>SKP/D/205/x</b>	x	x	x	x	x	
<b>SKP/D/MKT/150/x</b>	x	x	x	x	x	
<b>SKP/D/MKT/165/x</b>	x	x	x	x	x	
<b>SKP/D/MKT/180/x</b>	x	x	x	x	x	

### Systemy SKP / SAR

# SKO-P / G

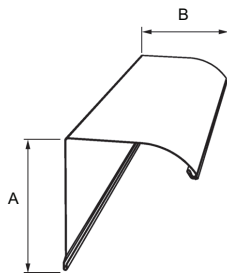

**Skrzynka roletowa systemu Owal - góra**  
**Rollladenkasten des OWAL-Systems – Oberteil**  
**Shutter box Owal - top**  
**Roletový box systému OWAL - horní strana**

Pakowanie: szt. x m | Packung: St. x m | Packing: pcs. x m | Balení: ks x m

	A	B	
<b>SKO-P/G/137/x</b>	141	131	5x6
<b>SKO-P/G/150/x</b>	154	143	5x6
<b>SKO-P/G/165/x</b>	168	157	5x6
<b>SKO-P/G/180/x</b>	184	171	5x6
<b>SKO-P/G/205/x</b>	206	195	5x6

x	Kolor   Farbe   Colour   Barva
<b>01</b>	srebrny   silber   silver   stříbrná
<b>02</b>	biały   weiß   white   bílá
<b>03</b>	szary   grau   grey   šedá
<b>08</b>	ciemnobrązowy   dunkelbraun   dark brown   tmavě hnědá
<b>09</b>	brązowy   braun   brown   hnědá
<b>NEW 15</b>	biel kremowa   cremeweiß   cream white   bílá krémová
<b>NEW 22</b>	ultra biały   ultraweiß   ultra white   ultra bílá
<b>23</b>	szary antracyt   anthrazitgrau   anthracite grey   antracitová šedá
<b>NEW 34</b>	kvarcowy szary   quarzgrau   quartz grey   křemenná šedá

	01	02	03	08	09	15	22	23	34
<b>SKO-P/G/137/x</b>	x	x	x	x	x	+	+	x	+
<b>SKO-P/G/150/x</b>	x	x	x	x	x				
<b>SKO-P/G/165/x</b>	x	x	x	x	x	+	+	x	+
<b>SKO-P/G/180/x</b>	x	x	x	x	x	+	+	x	+
<b>SKO-P/G/205/x</b>	x	x	x	x	x	+			+

Systemy SKO-P / SAR

# SKO-P / D

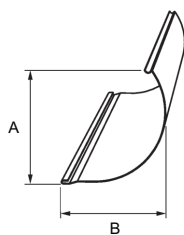

**Skrzynka roletowa systemu Owal - dół**  
**Rollladenkasten des OWAL-Systems - Unterteil**  
**Shutter box Owal system - base**  
**Roletový box systému OWAL - spodní strana**

Pakowanie: szt. x m | Packung: St. x m | Packing: pcs. x m | Balení: ks x m

	A	B	
<b>SKO-P/D/137/x</b>	113	111	5x6
<b>SKO-P/D/150/x</b>	122	125	5x6
<b>SKO-P/D/165/x</b>	133	134	5x6
<b>SKO-P/D/180/x</b>	145	150	5x6
<b>SKO-P/D/205/x</b>	163	167	5x6
<b>SKO-P/D/MKT/150/x</b>	122	111	5x6
<b>SKO-P/D/MKT/165/x</b>	134	123	5x6
<b>SKO-P/D/MKT/180/x</b>	145	143	5x6

x	Kolor   Farbe   Colour   Barva
<b>01</b>	srebrny   silber   silver   stříbrná
<b>02</b>	biały   weiß   white   bílá
<b>03</b>	szary   grau   grey   šedá
<b>08</b>	ciemnobrązowy   dunkelbraun   dark brown   tmavě hnědá
<b>09</b>	brązowy   braun   brown   hnědá
<b>NEW 15</b>	biel kremowa   cremeweiß   cream white   bílá krémová
<b>NEW 22</b>	ultra biały   ultraweiß   ultra white   ultra bílá
<b>23</b>	szary antracyt   anthrazitgrau   anthracite grey   antracitová šedá
<b>NEW 34</b>	kwarcowy szary   quarzgrau   quartz grey   křemenná šedá

	01	02	03	08	09	15	22	23	34
<b>SKO-P/D/137/x</b>	x	x	x	x	x	+	+	x	+
<b>SKO-P/D/150/x</b>	x	x	x	x	x				
<b>SKO-P/D/165/x</b>	x	x	x	x	x	+	+	x	+
<b>SKO-P/D/180/x</b>	x	x	x	x	x	+	+	x	+
<b>SKO-P/D/205/x</b>	x	x	x	x	x	+			+
<b>SKO-P/D/MKT/150/x</b>	x	x	x	x	x				
<b>SKO-P/D/MKT/165/x</b>	x	x	x	x	x				
<b>SKO-P/D/MKT/180/x</b>	x	x	x	x	x				

Systemy SKO-P / SAR

## SKO / G

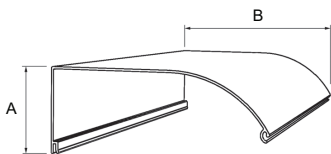

**Skrzynka roletowa systemu Owal - góra**  
**Rollladenkasten des OWAL-Systems – Oberteil**  
**Shutter box Owal - top**  
**Roletový box systému OWAL - horní strana**

Pakowanie: szt. x m | Packung: St. x m | Packing: pcs. x m | Balení: ks x m

	A	B	
<b>SKO/G/137/x</b>	11	137	5x6
<b>SKO/G/165/x</b>	39	163	5x6
<b>SKO/G/180/x</b>	52	177	5x6
<b>SKO/G/205/x</b>	79	201	5x6

x	Kolor   Farbe   Colour   Barva
<b>00</b>	nielakierowany   unlackiert   mill finish   nelakovaná
<b>01</b>	srebrny   silber   silver   stříbrná
<b>02</b>	biały   weiß   white   bílá
<b>03</b>	szary   grau   grey   šedá
<b>08</b>	ciemnobrązowy   dunkelbraun   dark brown   tmavě hnědá
<b>09</b>	brązowy   braun   brown   hnědá
<b>22</b>	ultra biały   ultraweiß   ultra white   ultra bílá
<b>23</b>	szary antracyt   anthrazitgrau   anthracite grey   antracitová šedá
<b>40S</b>	biały, perłowy mat   weiß, perlmutt matt   white, pearl mat   bílá, perlový mat
<b>41S</b>	jasny szary, perłowy mat   hellgrau, perlmutt matt   light grey, pearl mat   světle šedá, perlový mat
<b>42S</b>	szary, perłowy mat   grau, perlmutt matt   grey, pearl mat   šedá, perlový mat
<b>43S</b>	szary antracyt, perłowy mat   anthrazitgrau, perlmutt matt   anthracite grey, pearl mat   antracitová šedá, perlový mat
<b>44S</b>	ciemny szary, perłowy mat   dunkelgrau, perlmutt matt   dark grey, pearl mat   tmavě šedá, perlový mat

S - Oklejane folią dekoracyjną | mit Dekorfolie furniert | Decorative foil | Polep dekorativní folií

Systemy SKO / SAR

## SKO / D

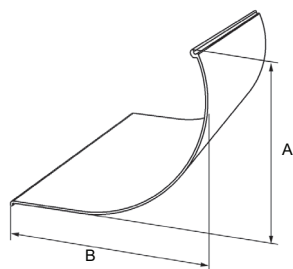

**Skrzynka roletowa systemu Owal - dół**  
**Rollladenkasten des OWAL-Systems - Unterteil**  
**Shutter box Owal system - base**  
**Roletový box systému OWAL - spodní strana**

Pakowanie: szt. x m | Packung: St. x m | Packing: pcs. x m | Balení: ks x m

	A	B	
<b>SKO/D/137/x</b>	107	102	5x6
<b>SKO/D/165/x</b>	128	130	5x6
<b>SKO/D/180/x</b>	139	145	5x6
<b>SKO/D/205/x</b>	159	171	5x6

**x Kolor | Farbe | Colour | Barva**

<b>00</b>	nie lakierowany   unlackiert   mill finish   nelakovaná
<b>01</b>	srebrny   silber   silver   stříbrná
<b>02</b>	biały   weiß   white   bílá
<b>03</b>	szary   grau   grey   šedá
<b>08</b>	ciemnobrązowy   dunkelbraun   dark brown   tmavě hnědá
<b>09</b>	brązowy   braun   brown   hnědá
<b>22</b>	ultra biały   ultraweiß   ultra white   ultra bílá
<b>23</b>	szary antracyt   anthrazitgrau   anthracite grey   antracitová šedá
<b>40S</b>	biały, perłowy mat   weiß, perlmutt matt   white, pearl mat   bílá, perlový mat
<b>41S</b>	jasny szary, perłowy mat   hellgrau, perlmutt matt   light grey, pearl mat   světle šedá, perlový mat
<b>42S</b>	szary, perłowy mat   grau, perlmutt matt   grey, pearl mat   šedá, perlový mat
<b>43S</b>	szary antracyt, perłowy mat   anthrazitgrau, perlmutt matt   anthracite grey, pearl mat   antracitová šedá, perlový mat
<b>44S</b>	ciemny szary, perłowy mat   dunkelgrau, perlmutt matt   dark grey, pearl mat   tmavě šedá, perlový mat

S - Oklejane folią dekoracyjną | mit Dekorfolie furniert | Decorative foil | Polep dekorativní folií

Systemy SKO / SAR

## SKO / T

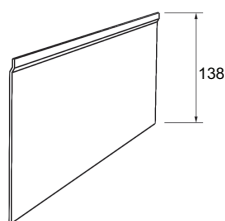

**Skrzynka roletowa systemu Owal - tył**  
**Rollladenkasten des OWAL-Systems – Hinterteil**  
**Shutter box Owal system - back part**  
**Roletový box systému OWAL - zadní strana**

Pakowanie: szt. x m | Packung: St. x m | Packing: pcs. x m | Balení: ks x m

- SKO/T/x**
- do zastosowania w skrzynkach typu SKO od 137 do 205
  - für die Verwendung im Kasten vom Typ SKO von 138 bis 205
  - used in shutter boxes SKO, size from 137 to 205
  - pro použití v boxech typu SKO od 137 do 205

x	Kolor   Farbe   Colour   Barva	
00	nielakierowany   unlackiert   mill finish   nelakovaná	5x6
01	srebrny   silber   silver   stříbrná	5x6
02	biały   weiß   white   bílá	5x6
03	szary   grau   grey   šedá	5x6
08	ciemnobrązowy   dunkelbraun   dark brown   tmavě hnědá	5x6
09	brązowy   braun   brown   hnědá	5x6
22	ultra biały   ultraweiß   ultra white   ultra bílá	5x6
23	szary antracyt   anthrazitgrau   anthracite grey   antracitová šedá	5x6
40S	biały, perłowy mat   weiß, perlmutt matt   white, pearl mat   bílá, perlový mat	5x6
41S	jasny szary, perłowy mat   hellgrau, perlmutt matt   light grey, pearl mat   světle šedá, perlový mat	5x6
42S	szary, perłowy mat   grau, perlmutt matt   grey, pearl mat   šedá, perlový mat	5x6
43S	szary antracyt, perłowy mat   anthrazitgrau, perlmutt matt   anthracite grey, pearl mat   antracitová šedá, perlový mat	5x6
44S	ciemny szary, perłowy mat   dunkelgrau, perlmutt matt   dark grey, pearl mat   tmavě šedá, perlový mat	5x6

S - Oklejane folią dekoracyjną | mit Dekorfolie furniert | Decorative foil | Polep dekorativní folií

### Systemy SKO / SAR

## SP 90 SK-E

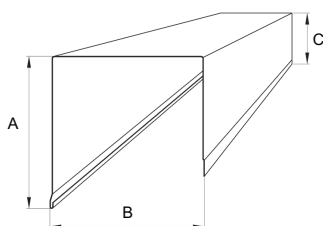

**Skrzynka roletowa SP-E**  
**Rollladenkasten SP-E**  
**Shutter box SP-E**  
**Roletový box SP-E**

Pakowanie: szt. x m | Packung: St. x m | Packing: pcs. x m | Balení: ks x m

	A	B	C	
<b>SP90SK-E/137/x</b>	137	137	98	5x6
<b>SP90SK-E/150/x</b>	150	150	112	5x6
<b>SP90SK-E/165/x</b>	165	164	126	5x6
<b>SP90SK-E/180/x</b>	180	180	142	5x6
<b>SP90SK-E/205/x</b>	205	205	167	5x6

x	Kolor   Farbe   Colour   Barva
00	nielakierowany   unlackiert   mill finish   nelakovaná

### Systemy SP-E / SAR

## SP 90 PR-E

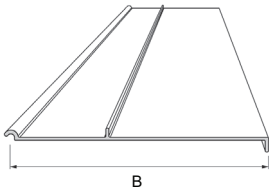

oklejane folią dekoracyjną  
mit Dekorfolie beklebt  
covered with a decorative foil  
polepeno dekorativní fólií

**Pokrywa rewizyjna skrzynki podtynkowej SP-E**  
**Revisionsklappe für Unterputzkasten SP-E**  
**Flap for under plaster shutter box SP-E**  
**Revizní kryt boxu pod omítkou SP-E**

Pakowanie: szt. x m | Packung: St. x m | Packing: pcs. x m | Balení: ks x m

	<b>B</b>	
<b>SP90PR-E/137/x</b>	111	5x6
<b>SP90PR-E/150/x</b>	126	5x6
<b>SP90PR-E/165/x</b>	139	5x6
<b>SP90PR-E/180/x</b>	150	5x6
<b>SP90PR-E/205/x</b>	171	5x6
<b>SP90PR-E/MKT/205/x</b>	165	5x6

<b>x</b>	<b>Kolor   Farbe   Colour   Barva</b>
<b>00</b>	nielakierowany   unlackiert   mill finish   nelakovaná
<b>01</b>	srebrny   silber   silver   stříbrná
<b>02</b>	biały   weiß   white   bílá
<b>03</b>	szary   grau   grey   šedá
<b>08</b>	ciemnobrązowy   dunkelbraun   dark brown   tmavě hnědá
<b>09</b>	brązowy   braun   brown   hnědá
<b>NEW 22</b>	ultra biały   ultraweiß   ultra white   ultra bílá
<b>23</b>	szary antracyt   anthrazitgrau   anthracite grey   antracitová šedá
<b>28R</b>	orzech   nuss   nut   ořech
<b>30R</b>	złoty dąb   goldeneiche   golden oak   zlatý dub
<b>40S</b>	biały, perłowy mat   weiß, perlmutt matt   white, pearl mat   bílá, perlový mat
<b>41S</b>	jasny szary, perłowy mat   hellgrau, perlmutt matt   light grey, pearl mat   světle šedá, perlový mat
<b>42S</b>	szary, perłowy mat   grau, perlmutt matt   grey, pearl mat   šedá, perlový mat
<b>43S</b>	szary antracyt, perłowy mat   anthrazitgrau, perlmutt matt   anthracite grey, pearl mat   antracitová šedá, perlový mat
<b>44S</b>	ciemny szary, perłowy mat   dunkelgrau, perlmutt matt   dark grey, pearl mat   tmavě šedá, perlový mat
<b>52R</b>	winchester   Winchester   winchester   winchester
<b>53R</b>	dąb ciemny   dunkel Eiche   dark oak   tmavý dub

R - Oklejane folią dekoracyjną | mit Dekorfolie furniert | Decorative foil | Polep dekorativní fólií

S - Oklejane folią dekoracyjną | mit Dekorfolie furniert | Decorative foil | Polep dekorativní fólií

Systemy SP-E / SAR

## SP 90 WPR-E

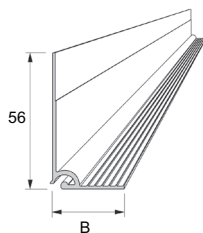

**Wspornik pokrywy rewizyjnej skrzynki podtynkowej SP-E**  
**Kragarm für Revisionsklappe des Unterputzkastens SP-E**  
**Bracket of flap for under plaster shutter box SP-E**  
**Vzpěra revizního krytu boxu pod omítkou SP-E**

Pakowanie: szt. x m | Packung: St. x m | Packing: pcs. x m | Balení: ks x m

	B	
<b>SP90WPR-E/15/x</b>	15	5x6
<b>SP90WPR-E/30/x</b>	30	5x6
<b>SP90WPR-E/45/x</b>	45	5x6
<b>SP90WPR-E/105/x</b>	105	5x6

x	Kolor   Farbe   Colour   Barva
<b>00</b>	nielakierowany   unlackiert   mill finish   nelakovaná
<b>01</b>	srebrny   silber   silver   stříbrná
<b>02</b>	biały   weiß   white   bílá
<b>03</b>	szary   grau   grey   šedá
<b>08</b>	ciemnobrązowy   dunkelbraun   dark brown   tmavě hnědá
<b>09</b>	brązowy   braun   brown   hnědá
<b>NEW 22</b>	ultra biały   ultraweiß   ultra white   ultra bílá
<b>23</b>	szary antracyt   anthrazitgrau   anthracite grey   antracitová šedá
<b>28R</b>	orzech   nuss   nut   ořech
<b>30R</b>	złoty dąb   goldeiche   golden oak   zlatý dub
<b>40S</b>	biały, perłowy mat   weiß, perlmutt matt   white, pearl mat   bílá, perlový mat
<b>41S</b>	jasny szary, perłowy mat   hellgrau, perlmutt matt   light grey, pearl mat   světle šedá, perlový mat
<b>42S</b>	szary, perłowy mat   grau, perlmutt matt   grey, pearl mat   šedá, perlový mat
<b>43S</b>	szary antracyt, perłowy mat   anthrazitgrau, perlmutt matt   anthracite grey, pearl mat   antracitová šedá, perlový mat
<b>44S</b>	ciemny szary, perłowy mat   dunkelgrau, perlmutt matt   dark grey, pearl mat   tmavě šedá, perlový mat
<b>52R</b>	winchester   Winchester   winchester   winchester
<b>53R</b>	dąb ciemny   dunkel Eiche   dark oak   tmavý dub

R - Oklejane folią dekoracyjną | mit Dekorfolie furniert | Decorative foil | Polep dekorativní fólií  
 S - Oklejane folią dekoracyjną | mit Dekorfolie furniert | Decorative foil | Polep dekorativní fólií

	00	01	02	03	08	09	22	23	28R	30R	40S	41S	42S	43S	44S	52R	53R
<b>SP90WPR-E/15/x</b>	x	x	x	x	x	x	+	x	x	x	x	x	x	x	x	x	x
<b>SP90WPR-E/30/x</b>	x	x	x	x	x	x	+	x	x	x	x	x	x	x	x	x	x
<b>SP90WPR-E/45/x</b>	x		x	x	x	x		x			x	x	x	x	x		
<b>SP90WPR-E/105/x</b>	x		x	x	x	x		x			x	x	x	x	x		

R - Oklejane folią dekoracyjną | mit Dekorfolie furniert | Decorative foil | Polep dekorativní fólií  
 S - Oklejane folią dekoracyjną | mit Dekorfolie furniert | Decorative foil | Polep dekorativní fólií

### Systemy SP-E / SAR

## SP 90 SPD-E

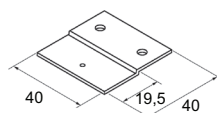

**Listwa dystansowa do skrzynki podtynkowej SP-E**  
**Distanzleiste für Unterputzkasten SP-E**  
**Distance slat for under plaster shutter box SP-E**  
**Distanční lišta k boxu pod omítkou SP-E**

Pakowanie: 100 szt. | Packung: 100 St. | Packing: 100 pcs | Balení: 100 ks

### SP90SPD-E

### Systemy SP-E / SAR



## SP 90 PZ

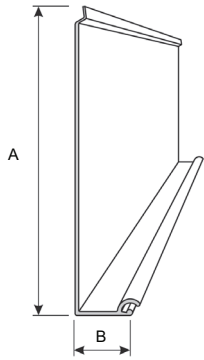

oklejane folią dekoracyjną  
mit Dekorfolie beklebt  
covered with a decorative foil  
polepeno dekorativní fólií

### Pokrywa zewnętrzna skrzynki podtynkowej SP

### Außenelement des Unterputzkastens SP

### Outer cap for under plaster shutter box SP

### Vnější kryt boxu pod omítkou SP

Pakowanie: szt. x m | Packung: St. x m | Packing: pcs. x m | Balení: ks x m

	A	B	
<b>SP90PZ/137/x</b>	127	26	5x6
<b>SP90PZ/165/x</b>	155	29	5x6
<b>SP90PZ/180/x</b>	171	37	5x6
<b>SP90PZ/205/x</b>	195	37	5x6

x	Kolor   Farbe   Colour   Barva
<b>00</b>	nie lakierowany   unlackiert   mill finish   nelakovaná
<b>01</b>	srebrny   silber   silver   stříbrná
<b>02</b>	biały   weiß   white   bílá
<b>03</b>	szary   grau   grey   šedá
<b>08</b>	ciemnobrązowy   dunkelbraun   dark brown   tmavě hnědá
<b>09</b>	brązowy   braun   brown   hnědá
<b>23</b>	szary antracyt   anthrazitgrau   anthracite grey   antracitová šedá
<b>28R</b>	orzech   nuss   nut   ořech
<b>30R</b>	złoty dąb   goldeiche   golden oak   zlatý dub
<b>40S</b>	biały, perłowy mat   weiß, perlmutt matt   white, pearl mat   bílá, perlový mat
<b>41S</b>	jasny szary, perłowy mat   hellgrau, perlmutt matt   light grey, pearl mat   světle šedá, perlový mat
<b>42S</b>	szary, perłowy mat   grau, perlmutt matt   grey, pearl mat   šedá, perlový mat
<b>43S</b>	szary antracyt, perłowy mat   anthrazitgrau, perlmutt matt   anthracite grey, pearl mat   antracitová šedá, perlový mat
<b>44S</b>	ciemny szary, perłowy mat   dunkelgrau, perlmutt matt   dark grey, pearl mat   tmavě šedá, perlový mat

R - Oklejane folią dekoracyjną | mit Dekorfolie furniert | Decorative foil | Polep dekorativní fólií

S - Oklejane folią dekoracyjną | mit Dekorfolie furniert | Decorative foil | Polep dekorativní fólií

## SP 90 PR

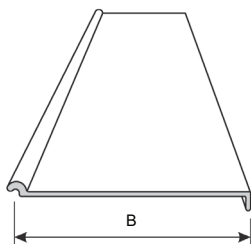

oklejane folią dekoracyjną  
mit Dekorfolie beklebt  
covered with a decorative foil  
polepeno dekorativní fólií

**Pokrywa rewizyjna skrzynki podtynkowej SP**  
**Revisionsklappe des Unterputzkastens SP**  
**Flap for under plaster shutter box SP**  
**Revizní kryt boxu pod omítkou SP**

Pakowanie: szt. x m | Packung: St. x m | Packing: pcs. x m | Balení: ks x m

	<b>B</b>	
<b>SP90PR/137/x</b>	82	5x6
<b>SP90PR/165/x</b>	100	5x6
<b>SP90PR/180/x</b>	109	5x6
<b>SP90PR/205/x</b>	134	5x6

<b>x</b>	<b>Kolor   Farbe   Colour   Barva</b>
<b>00</b>	nielakerowany   unlackiert   mill finish   nelakovaná
<b>01</b>	srebrny   silber   silver   stříbrná
<b>02</b>	biały   weiß   white   bílá
<b>03</b>	szary   grau   grey   šedá
<b>08</b>	ciemnobrązowy   dunkelbraun   dark brown   tmavě hnědá
<b>09</b>	brązowy   braun   brown   hnědá
<b>23</b>	szary antracyt   anthrazitgrau   anthracite grey   antracitová šedá
<b>28R</b>	orzech   nuss   nut   ořech
<b>30R</b>	złoty dąb   goldeiche   golden oak   zlatý dub
<b>40S</b>	biały, perłowy mat   weiß, perlmutt matt   white, pearl mat   bílá, perlový mat
<b>41S</b>	jasny szary, perłowy mat   hellgrau, perlmutt matt   light grey, pearl mat   světle šedá, perlový mat
<b>42S</b>	szary, perłowy mat   grau, perlmutt matt   grey, pearl mat   šedá, perlový mat
<b>43S</b>	szary antracyt, perłowy mat   anthrazitgrau, perlmutt matt   anthracite grey, pearl mat   antracitová šedá, perlový mat
<b>44S</b>	ciemny szary, perłowy mat   dunkelgrau, perlmutt matt   dark grey, pearl mat   tmavě šedá, perlový mat

R - Oklejane folią dekoracyjną | mit Dekorfolie furniert | Decorative foil | Polep dekorativní fólií  
S - Oklejane folią dekoracyjną | mit Dekorfolie furniert | Decorative foil | Polep dekorativní fólií

Systemy SP / SAR

## SPS 90

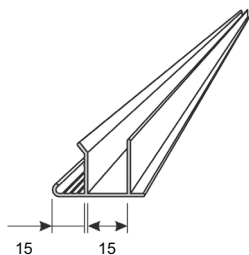

oklejane folią dekoracyjną  
mit Dekorfolie beklebt  
covered with a decorative foil  
polepeno dekorativní fólií

**Szyna tynkowa**  
**Putzchiene für Unterputzkasten SP**  
**Bar for under plaster shutter box SP**  
**Omitková kolejnice k boxům pod omítkou SP**

Pakowanie: szt. x m | Packung: St. x m | Packing: pcs. x m | Balení: ks x m

### SPS90/x

x	Kolor   Farbe   Colour   Barva	
00	nielakierowany   unlackiert   mill finish   nelakovaná	5x6
01	srebrny   silber   silver   stříbrná	5x6
02	biały   weiß   white   bílá	5x6
03	szary   grau   grey   šedá	5x6
08	ciemnobrązowy   dunkelbraun   dark brown   tmavě hnědá	5x6
09	brązowy   braun   brown   hnědá	5x6
23	szary antracyt   anthrazitgrau   anthracite grey   antracitová šedá	5x6
28R	orzech   nuss   nut   ořech	5x6
30R	złoty dąb   goldeiche   golden oak   zlatý dub	5x6
40S	biały, perłowy mat   weiß, perlmutt matt   white, pearl mat   bílá, perlový mat	5x6
41S	jasny szary, perłowy mat   hellgrau, perlmutt matt   light grey, pearl mat   světle šedá, perlový mat	5x6
42S	szary, perłowy mat   grau, perlmutt matt   grey, pearl mat   šedá, perlový mat	5x6
43S	szary antracyt, perłowy mat   anthrazitgrau, perlmutt matt   anthracite grey, pearl mat   antracitová šedá, perlový mat	5x6
44S	ciemny szary, perłowy mat   dunkelgrau, perlmutt matt   dark grey, pearl mat   tmavě šedá, perlový mat	5x6

R - Oklejane folią dekoracyjną | mit Dekorfolie furniert | Decorative foil | Polep dekorativní fólií  
S - Oklejane folią dekoracyjną | mit Dekorfolie furniert | Decorative foil | Polep dekorativní fólií

### Systemy SP / SAR

## KT 30

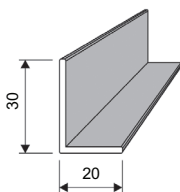

**Kątownik aluminiowy**  
**Aluminium-Winkel**  
**Aluminium angle**  
**Hliníkový úhelník**

Pakowanie: szt. x m | Packung: St. x m | Packing: pcs. x m | Balení: ks x m

### KT30/x

- do podparcia prowadnicy lub jako nośnik tynku
- zur Stütze der Führungsschiene oder als Putzträger
- to support the guide channel or as plaster foundation
- k podepření vodící lišty nebo jako vzpěra pro nosič omítky

x	Kolor   Farbe   Colour   Barva	
00	nielakierowany   unlackiert   mill finish   nelakovaná	1x6
01	srebrny   silber   silver   stříbrná	1x6
02	biały   weiß   white   bílá	1x6
03	szary   grau   grey   šedá	1x6
05	beżowy   beige   beige   béžová	1x6
08	ciemnobrązowy   dunkelbraun   dark brown   tmavě hnědá	1x6
09	brązowy   braun   brown   hnědá	1x6
<b>NEW</b> 22	ultra biały   ultraweiß   ultra white   ultra bílá	1x6
23	szary antracyt   anthrazitgrau   anthracite grey   antracitová šedá	1x6

### Systemy SK / SKE / SKO / SKO-P / SKP / SP / SP-E

## SPZ 90

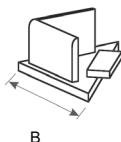

**Zašlepka do skrzynki podtynkowej SP**  
**Eckelement für Unterputzkasten SP**  
**Blind for under plaster shutter box SP**  
**Záslepka k boxu pod omítkou SP**

Pakowanie: szt. | Packung: St. | Packing: pcs | Balení: ks

	<b>B</b>	
<b>SPZ90/137/x</b>	36	100
<b>SPZ90/165/x</b>	47	100
<b>SPZ90/180/x</b>	50	100
<b>SPZ90/205/x</b>	55	100

<b>x</b>	<b>Kolor   Farbe   Colour   Barva</b>
<b>02</b>	biały   weiß   white   bílá
<b>08</b>	ciemnobrązowy   dunkelbraun   dark brown   tmavě hnědá
<b>09</b>	brązowy   braun   brown   hnědá
<b>23</b>	szary antracyt   anthrazitgrau   anthracite grey   antracitová šedá
<b>32</b>	karmel   karamel   caramel   karamel

### Systemy SP / SAR

## SPD 90

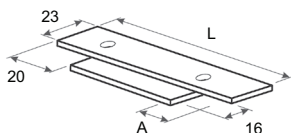

**Listwa dystansowa do skrzynki podtynkowej SP**  
**Distanzleiste für Unterputzkasten SP**  
**Distance slat for under plaster shutter box SP**  
**Distanční lišta k boxu pod omítkou SP**

Pakowanie: szt. | Packung: St. | Packing: pcs | Balení: ks

	<b>A</b>	<b>L</b>	
<b>SPD90/137/x</b>	15	76	100
<b>SPD90/165/x</b>	20	99	100
<b>SPD90/180/x</b>	20	108	100
<b>SPD90/205/x</b>	20	133	100

<b>x</b>	<b>Kolor   Farbe   Colour   Barva</b>
<b>02</b>	biały   weiß   white   bílá
<b>03</b>	szary   grau   grey   šedá
<b>08</b>	ciemnobrązowy   dunkelbraun   dark brown   tmavě hnědá
<b>09</b>	brązowy   braun   brown   hnědá
<b>23</b>	szary antracyt   anthrazitgrau   anthracite grey   antracitová šedá
<b>32</b>	karmel   karamel   caramel   karamel

### Systemy SP / SAR

## WZ 90 PR

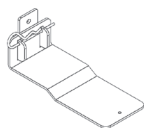

**Wzmocnienie pokrywy rewizyjnej**  
**Verstärkung der Revisionsklappe**  
**Shutter box reinforcement**  
**Zpevnění revizního krytu**

Pakowanie: 1 szt. | Packung: 1 St. | Packing: 1 pcs | Balení: 1 ks

- WZ90PR/119**
- stosowane w skrzynkach: SP 165; SP-E 165
  - verwendet in den Kästen: SP 165; SP-E 165
  - used in shutter boxes: SP 165; SP-E 165
  - používáno v boxech: SP 165; SP-E 165
- WZ90PR/140**
- stosowane w skrzynkach: SP 180; SP 205; SP-E 180; SP-E 205
  - verwendet in den Kästen: SP 180; SP 205; SP-E 180; SP-E 205
  - used in shutter boxes: SP 180; SP 205; SP-E 180; SP-E 205
  - používáno v boxech: SP 180; SP 205; SP-E 180; SP-E 205

### Systemy SP / SP-E / SAR

## K/PU

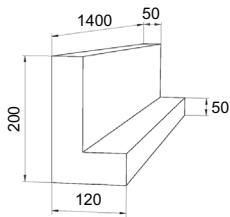

**Kątownik poliuretanowy**  
**Polyurethan-Winkel**  
**Polyurethane angle**  
**Polyuretanový úhelník**

Pakowanie: 1 szt. | Packung: 1 St. | Packing: 1 pcs | Balení: 1 ks

**K/PU**

- kątownik stosowany do montażu skrzynki z nadprożem. Wymagany przy montażu PHI
- Winkel - verwendet zur Montage des Kastens mit dem Sturz. Erforderlich bei der PHI Montage
- angle used to mount the box with the lintel. Required for installation of PHI
- úhelník používaný k montáži boxu do nadpraží. Nutné při montáži PHI

Systemy SP / SP-E

## TR/25x13

**NEW**

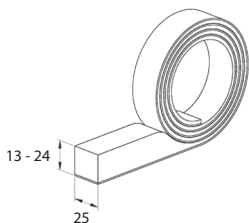

**Taśma rozprężna**  
**Ausdehnungsband**  
**Expansion tape**  
**Expanzní páska**

Pakowanie: 1x6,6 szt. x m | Packung: 1x6,6 St. x m | Packing: 1x6,6 pcs. x m | Balení: 1x6,6 ks x m

**TR/25x13**

- taśma stosowana do uszczelnienia spoin. Wymagana przy montażu PHI
- Band verwendet zur versiegelung der Fugen. Erforderlich bei der PHI Montage.
- tape used to seal joints. Required for installation of PHI
- páska používaná pro utěsnění spojů. Nutné při montáži PHI

Systemy SP / SP-E

## NT/XPS

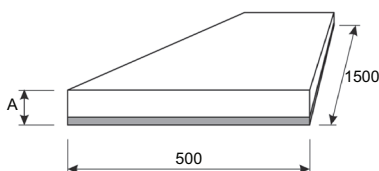

**Nośnik tynku (Styrodur XPS)**  
**Putzträger (Styrodur XPS)**  
**Plaster foundation (Styrodur XPS)**  
**Nosič omítky (Styrodur XPS)**

Pakowanie: szt. | Packung: St. | Packing: pcs | Balení: ks

**NT/XPS**

- posiada powłokę samoprzylepną, stosowany z: SP 90 WPR-E, SPS 90, KT 30, NT
- mit Selbstklebendbeschichtung, verwendet mit: SP 90 WPR-E, SPS 90, KT 30, NT
- it has a self-adhesive layer, used with: SP 90 WPR-E, SPS 90, KT 30, NT
- Je vybaven samolepicím povrchem, používáno s: SP 90 WPR-E, SPS 90, KT 30, NT

	A	
<b>NT/XPS/8</b>	8	1
<b>NT/XPS/10</b>	10	1
<b>NT/XPS/16</b>	16	1
<b>NT/XPS/22</b>	22	1

Systemy SP / SP-E / SKT / SAR

## NT/HR

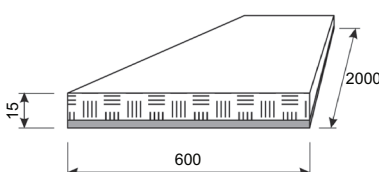

**Nośnik tynku (Heraklith)**  
**Putzträger (Heraklith)**  
**Plaster foundation (Heraklith)**  
**Nosič omítky (Heraklith)**

Pakowanie: 1 szt. | Packung: 1 St. | Packing: 1 pcs | Balení: 1 ks

**NT/HR**

- stosowany z: SP 90 WPR-E, SPS 90, KT 30
- verwendet mit: SP 90 WPR-E, SPS 90, KT 30
- used with: SP 90 WPR-E, SPS 90, KT 30
- používáno s: SP 90 WPR-E, SPS 90, KT 30

Systemy SP / SP-E / SAR

## WPB

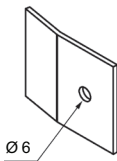

### Wspornik do montażu pokryw bocznych Montageplatte für Blendenkappen Plate for end caps Podpěra pro montáž bočních krytů

Pakowanie: 1 szt. | Packung: 1 St. | Packing: 1 pcs | Balení: 1 ks

#### WPB

- do montażu pokryw bocznych: BS\_45, BS 45, BSP, BSO, BS 90
- für die Montage der Blendenkappen: BS\_45, BS 45, BSP, BSO, BS 90
- for end caps installation: BS\_45, BS 45, BSP, BSO, BS 90
- k montáži bočních krytů: BS\_45, BS 45, BSP, BSO, BS 90

Systemy SK / SKE / SKP / SKO / SKO-P / SP / SP-E / SAR

## BS 45

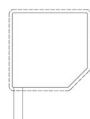
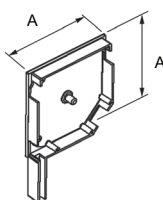

oklejane folią dekoracyjną  
mit Dekorfolie beklebt  
covered with a decorative foil  
polepeno dekorativní fólií

### Pokrywa boczna skrzynki 45° - stopka typ I Blendenkappen 45° - Bolzen Typ I End cap 45° - pin type I Boční kryt boxu 45° - patka typu I

Pakowanie: para | Packung: Paar | Packing: pair | Balení: pár

	A	
<b>BS45/125/x</b>	126	25
<b>BS45/137/x</b>	138	25
<b>BS45/150/x</b>	151	25
<b>BS45/165/x<sup>1)</sup></b>	166	25
<b>BS45/180/x<sup>1)</sup></b>	181	25
<b>BS45/205/x<sup>1)</sup></b>	206	15

#### x Kolor | Farbe | Colour | Barva

<b>00</b>	nie lakierowany   unlackiert   mill finish   nelakovaná
<b>01</b>	srebrny   silber   silver   stříbrná
<b>02</b>	biały   weiß   white   bílá
<b>03</b>	szary   grau   grey   šedá
<b>05</b>	beżowy   beige   beige   béžová
<b>08</b>	ciemnobrązowy   dunkelbraun   dark brown   tmavě hnědá
<b>09</b>	brązowy   braun   brown   hnědá
<b>15</b>	biel kremowa   cremeweiß   cream white   bílá krémová
<b>22</b>	ultra biały   ultraweiß   ultra white   ultra bílá
<b>23</b>	szary antracyt   anthrazitgrau   anthracite grey   antracitová šedá
<b>26R</b>	mahoń   mahagoni   mahogany   mahagon
<b>28</b>	orzech   nuss   nut   ořech
<b>28R</b>	orzech   nuss   nut   ořech
<b>NEW 30</b>	złoty dąb   goldeiche   golden oak   zlatý dub
<b>30R</b>	złoty dąb   goldeiche   golden oak   zlatý dub
<b>32</b>	karmel   karamel   caramel   karamel

R - Oklejane folią dekoracyjną | mit Dekorfolie furniert | Decorative foil | Polep dekorativní fólií

	00	01	02	03	05	08	09	15	22	23	26R	28	28R	30	30R	32
<b>BS45/125/x</b>	x		x	x		x	x		x	x						
<b>BS45/137/x</b>	x	x	x	x	x	x	x	x	x	x	x	x	x	x	x	x
<b>BS45/150/x</b>	x	x	x	x	x	x	x	x	x	x				+	x	x
<b>BS45/165/x</b>	x	x	x	x	x	x	x	x	x	x	x	x	x	x	x	x
<b>BS45/180/x</b>	x	x	x	x	x	x	x	x	x	x	x	x	x	x	x	x
<b>BS45/205/x</b>	x	x	x	x	x	x	x	x		x	x	x	x	x	x	x

R - Oklejane folią dekoracyjną | mit Dekorfolie furniert | Decorative foil | Polep dekorativní fólií

<sup>1)</sup> Dostępne do wyczerpania zapasów | Erhältlich solange der Vorrat reicht | Available while stock lasts | Dostupné do vyčerpání zásob

Systemy SK / SP / SAR

## BS\_45

**NEW**

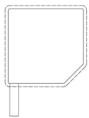
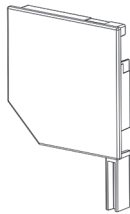
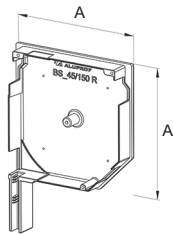

oklejane folią dekoracyjną  
mit Dekorfolie beklebt  
covered with a decorative foil  
polepeno dekorativní fólií

### Pokrywa boczna skrzynki 45° - stopka typ I

Blendenkappen 45° - Bolzen Typ I

End cap 45° - pin type I

Boční kryt boxu 45° - patka typu I

Pakowanie: para | Packung: Paar | Packing: pair | Balení: pár

	A	
<b>BS_45/137/x</b>	140	25
<b>BS_45/165/x</b>	168	25
<b>BS_45/180/x</b>	183	25
<b>BS_45/205/x</b>	208	15

x	Kolor   Farbe   Colour   Barva
<b>00</b>	nie lakierowany   unlackiert   mill finish   nelakovaná
<b>01</b>	srebrny   silber   silver   stříbrná
<b>02</b>	biały   weiß   white   bílá
<b>03</b>	szary   grau   grey   šedá
<b>05</b>	beżowy   beige   beige   béžová
<b>08</b>	ciemnobrązowy   dunkelbraun   dark brown   tmavě hnědá
<b>09</b>	brązowy   braun   brown   hnědá
<b>15</b>	biel kremowa   cremeweiß   cream white   bílá krémová
<b>22</b>	ultra biały   ultraweiß   ultra white   ultra bílá
<b>23</b>	szary antracyt   anthrazitgrau   anthracite grey   antracitová šedá
<b>26R</b>	mahoń   mahagoni   mahogany   mahagon
<b>28</b>	orzech   nuss   nut   ořech
<b>28R</b>	orzech   nuss   nut   ořech
<b>30</b>	złoty dąb   goldeiche   golden oak   zlatý dub
<b>30R</b>	złoty dąb   goldeiche   golden oak   zlatý dub
<b>32</b>	karmel   karamel   caramel   karamel
<b>NEW 34</b>	kwarcowy szary   quarzgrau   quartz grey   křemenná šedá

R - Oklejane folią dekoracyjną | mit Dekorfolie furniert | Decorative foil | Polep dekorativní fólií

	00	01	02	03	05	08	09	15	22	23	26R	28	28R	30	30R	32	34
<b>BS_45/137/x</b>	x	x	x	x	x	x	x	x	x	x	x	x	x	x	x	x	+
<b>BS_45/165/x</b>	x	x	x	x	x	x	x	x	x	x	x	x	x	x	x	x	+
<b>BS_45/180/x</b>	x	x	x	x	x	x	x	x	x	x	x	x	x	x	x	x	+
<b>BS_45/205/x</b>	x	x	x	x	x	x	x	x		x	x	x	x	x	x	x	+

R - Oklejane folią dekoracyjną | mit Dekorfolie furniert | Decorative foil | Polep dekorativní fólií

Systemy SK / SKE / SP / SAR

## BSW 45

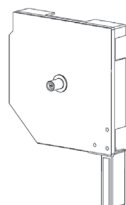
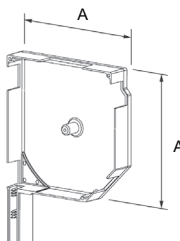

### Bok skrzynki 45° wewnętrzny - stopka typ I

Innenblendenkappen 45° - Bolzen Typ I

Internal end cap 45° - pin type I

Bok boxu 45° wnitřní - patka typu I

Pakowanie: para | Packung: Paar | Packing: pair | Balení: pár

	A	
<b>BSW45/137/x</b>	135	1
<b>BSW45/150/x</b>	148	1
<b>BSW45/165/x<sup>1)</sup></b>	163	1
<b>BSW45/180/x<sup>1)</sup></b>	178	1
<b>BSW45/205/x<sup>1)</sup></b>	203	1

x	Kolor   Farbe   Colour   Barva
<b>00</b>	nie lakierowany   unlackiert   mill finish   nelakovaná

<sup>1)</sup> Dostępne do wyczerpania zapasów | Erhältlich solange der Vorrat reicht | Available while stock lasts | Dostupné do vyčerpání zásob

Systemy SK / SP

## BSW\_45

**NEW**

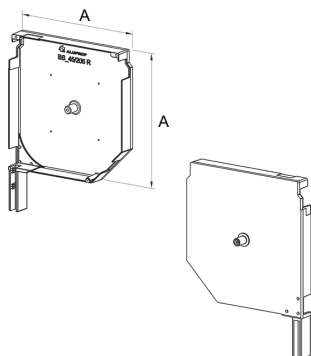

**Bok skrzynki 45° wewnętrzny - stopka typ I**  
**Innenblendenkappen 45° - Bolzen Typ I**  
**Internal end cap 45° - pin type I**  
**Bok boxu 45° vnitřní - patka typu I**

Pakowanie: para | Packung: Paar | Packing: pair | Balení: pár

	A	
<b>BSW_45/137/x</b>	135	1
<b>BSW_45/165/x</b>	163	1
<b>BSW_45/180/x</b>	178	1
<b>BSW_45/205/x</b>	203	1

**x Kolor | Farbe | Colour | Barva**

**00** nielakierowany | unlackiert | mill finish | nelakovaná

Systemy SK / SKE / SP

## BSWZ 45

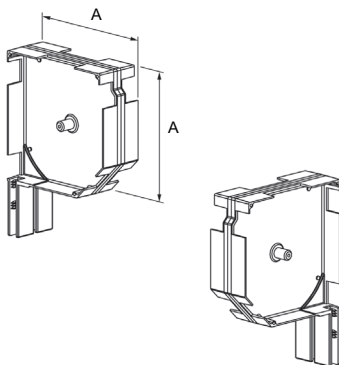

**Boki skrzynki 45° wewnętrzne, zespolone - stopka typ I**  
**Zusammengesetzte Innenblendenkappen 45° - Bolzen Typ I**  
**Compound internal end caps 45° - pin type I**  
**Boky boxu 45° vnitřně spojené - patka typu I**

Pakowanie: szt. | Packung: St. | Packing: pcs | Balení: ks

	A	
<b>BSWZ45/137/x</b>	135	1
<b>BSWZ45/150/x</b>	148	1
<b>BSWZ45/165/x<sup>1)</sup></b>	163	1
<b>BSWZ45/180/x<sup>1)</sup></b>	178	1
<b>BSWZ45/205/x<sup>1)</sup></b>	203	1

**x Kolor | Farbe | Colour | Barva**

**00** nielakierowany | unlackiert | mill finish | nelakovaná

<sup>1)</sup> Dostępne do wyczerpania zapasów | Erhältlich solange der Vorrat reicht | Available while stock lasts | Dostupné do vyčerpání zásob

Systemy SK / SP / SAR

## BSWZ\_45

**NEW**

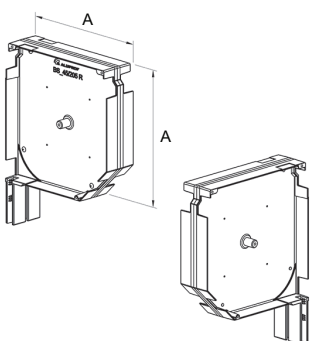

**Boki skrzynki 45° wewnętrzne, zespolone - stopka typ I**  
**Zusammengesetzte Innenblendenkappen 45° - Bolzen Typ I**  
**Compound internal end caps 45° - pin type I**  
**Boky boxu 45° vnitřně spojené - patka typu I**

Pakowanie: szt. | Packung: St. | Packing: pcs | Balení: ks

	A	
<b>BSWZ_45/137/x</b>	135	1
<b>BSWZ_45/165/x</b>	163	1
<b>BSWZ_45/180/x</b>	178	1
<b>BSWZ_45/205/x</b>	203	1

**x Kolor | Farbe | Colour | Barva**

**00** nielakierowany | unlackiert | mill finish | nelakovaná

Systemy SK / SKE / SP / SAR



## BSWN 45

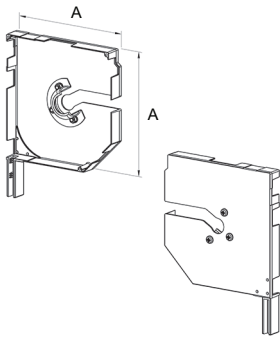

**Bok skrzynki 45° wewnętrzny, wspólny napęd - stopka typ I**  
**Innenblendenkappen 45°, gemeinsamer Antrieb - Bolzen Typ I**  
**Internal end cap 45°, common drive - pin type I**  
**Bok boxu 45° vnitřní, společný pohon - patka typu I**

Pakowanie: para | Packung: Paar | Packing: pair | Balení: pár

	A	
<b>BSWN45/150/x</b>	148	1
<b>BSWN45/165/x<sup>1)</sup></b>	163	1
<b>BSWN45/180/x<sup>1)</sup></b>	178	1
<b>BSWN45/205/x<sup>1)</sup></b>	203	1

**x Kolor | Farbe | Colour | Barva**

**00** nielakierowany | unlackiert | mill finish | nelakovaná

<sup>1)</sup> Dostępne do wyczerpania zapasów | Erhältlich solange der Vorrat reicht | Available while stock lasts | Dostupné do vyčerpání zásob

System SK

## BSWN\_45

**NEW**

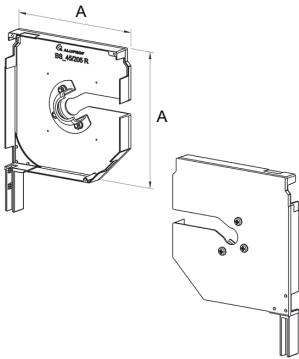

**Bok skrzynki 45° wewnętrzny, wspólny napęd - stopka typ I**  
**Innenblendenkappen 45°, gemeinsamer Antrieb - Bolzen Typ I**  
**Internal end cap 45°, common drive - pin type I**  
**Bok boxu 45° vnitřní, společný pohon - patka typu I**

Pakowanie: para | Packung: Paar | Packing: pair | Balení: pár

	A	
<b>BSWN_45/165/x</b>	163	1
<b>BSWN_45/180/x</b>	178	1
<b>BSWN_45/205/x</b>	203	1

**x Kolor | Farbe | Colour | Barva**

**00** nielakierowany | unlackiert | mill finish | nelakovaná

Systemy SK / SKE

## BSP

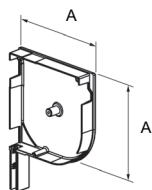

### Pokrywa boczna skrzynki - stopka typ I

Blendenkappen - Bolzen Typ I

End cap - pin type I

Boční kryt boxu - patka typu I

Pakowanie: para | Packung: Paar | Packing: pair | Balení: pár

	A	
<b>BSP/137/x</b>	137	25
<b>BSP/150/x</b>	151	25
<b>BSP/165/x</b>	166	25
<b>BSP/180/x</b>	181	25
<b>BSP/205/x</b>	206	25

#### x Kolor | Farbe | Colour | Barva

**00** nielakierowany | unlackiert | mill finish | nelakovaná

**01** srebrny | silber | silver | stříbrná

**02** biały | weiß | white | bílá

**03** szary | grau | grey | šedá

**08** ciemnobrązowy | dunkelbraun | dark brown | tmavě hnědá

**09** brązowy | braun | brown | hnědá

**NEW 23** szary antracyt | anthrazitgrau | anthracite grey | antracitová šedá

	00	01	02	03	08	09	23
<b>BSP/137/x</b>	x	x	x	x	x	x	+
<b>BSP/150/x</b>	x	x	x	x	x	x	
<b>BSP/165/x</b>	x	x	x	x	x	x	+
<b>BSP/180/x</b>	x	x	x	x	x	x	+
<b>BSP/205/x</b>	x	x	x	x	x	x	

## Systemy SKP / SAR

## BSPW

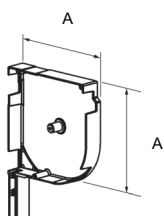

### Bok skrzynki wewnętrzny - stopka typ I

Innenblendenkappen - Bolzen Typ I

Internal end cap - pin type I

Bok boxu vnitřní - patka typu I

Pakowanie: para | Packung: Paar | Packing: pair | Balení: pár

	A	
<b>BSPW/137/x</b>	135	1
<b>BSPW/150/x</b>	148	1
<b>BSPW/165/x</b>	163	1
<b>BSPW/180/x</b>	178	1
<b>BSPW/205/x</b>	203	1

#### x Kolor | Farbe | Colour | Barva

**00** nielakierowany | unlackiert | mill finish | nelakovaná

## System SKP

## BSPWZ

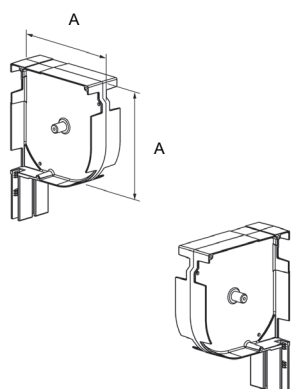

**Boki skrzynki wewnętrzne, zespolone - stopka typ I**  
**Zusammengesetzte Innenblendenkappen - Bolzen Typ I**  
**Compound internal end caps - pin type I**  
**Boky boxu vnitřně spojené - patka typu I**

Pakowanie: szt. | Packung: St. | Packing: pcs | Balení: ks

	A	
<b>BSPWZ/137/x</b>	135	1
<b>BSPWZ/150/x</b>	148	1
<b>BSPWZ/165/x</b>	163	1
<b>BSPWZ/180/x</b>	178	1
<b>BSPWZ/205/x</b>	203	1

**x Kolor | Farbe | Colour | Barva**

**00** nielakierowany | unlackiert | mill finish | nelakovaná

Systemy SKP / SAR

## BSPWN

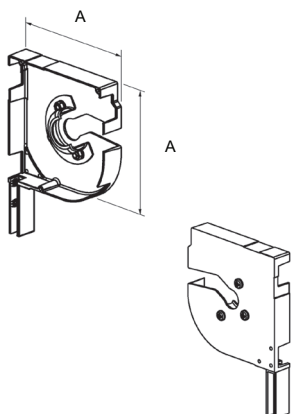

**Bok skrzynki wewnętrzny, wspólny napęd - stopka typ I**  
**Innenblendenkappen, gemeinsamer Antrieb - Bolzen Typ I**  
**Internal end cap, common drive - pin type I**  
**Bok boxu vnitřní, společný pohon - patka typu I**

Pakowanie: para | Packung: Paar | Packing: pair | Balení: pár

	A	
<b>BSPWN/150/x</b>	148	1
<b>BSPWN/165/x</b>	163	1
<b>BSPWN/180/x</b>	178	1
<b>BSPWN/205/x</b>	203	1

**x Kolor | Farbe | Colour | Barva**

**00** nielakierowany | unlackiert | mill finish | nelakovaná

System SKP

# BSO

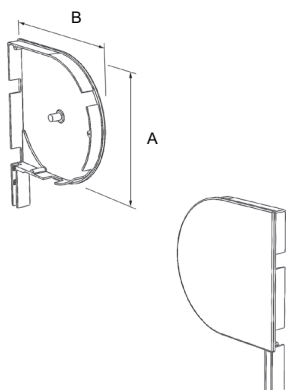

## Pokrywa boczna skrzynki owalnej - stopka typ I

### Rund-Blendenkappen - Bolzen Typ I

### Round end cap - pin type I

### Boční kryt oválného boxu - patka typu I

Pakowanie: para | Packung: Paar | Packing: pair | Balení: pár

	A	B	
<b>BSO/137/x</b>	142	147	25
<b>BSO/150/x<sup>1)</sup></b>	155	160	25
<b>BSO/165/x</b>	170	175	25
<b>BSO/180/x</b>	185	190	25
<b>BSO/205/x</b>	212	217	25

x	Kolor   Farbe   Colour   Barva
<b>00</b>	nie lakierowany   unlackiert   mill finish   nelakovaná
<b>01</b>	srebrny   silber   silver   stříbrná
<b>02</b>	biały   weiß   white   bílá
<b>03</b>	szary   grau   grey   šedá
<b>08</b>	ciemnobrązowy   dunkelbraun   dark brown   tmavě hnědá
<b>09</b>	brązowy   braun   brown   hnědá
<b>NEW 15</b>	biel kremowa   cremeweiß   cream white   bílá krémová
<b>NEW 22</b>	ultra biały   ultraweiß   ultra white   ultra bílá
<b>23</b>	szary antracyt   anthrazitgrau   anthracite grey   antracitová šedá
<b>NEW 34</b>	kvarcowy szary   quarzgrau   quartz grey   křemenná šedá
<b>40S</b>	biały, perłowy mat   weiß, perlmutt matt   white, pearl mat   bílá, perlový mat
<b>41S</b>	jasny szary, perłowy mat   hellgrau, perlmutt matt   light grey, pearl mat   světle šedá, perlový mat
<b>42S</b>	szary, perłowy mat   grau, perlmutt matt   grey, pearl mat   šedá, perlový mat
<b>43S</b>	szary antracyt, perłowy mat   anthrazitgrau, perlmutt matt   anthracite grey, pearl mat   antracitová šedá, perlový mat
<b>44S</b>	ciemny szary, perłowy mat   dunkelgrau, perlmutt matt   dark grey, pearl mat   tmavě šedá, perlový mat

S - Oklejane folią dekoracyjną | mit Dekorfolie furniert | Decorative foil | Polep dekorativní folií

	00	01	02	03	08	09	15	22	23	34	40S	41S	42S	43S	44S
<b>BSO/137/x</b>	x	x	x	x	x	x	+	+	x	+	x	x	x	x	x
<b>BSO/150/x</b>	x	x	x	x	x	x			x		x	x	x	x	x
<b>BSO/165/x</b>	x	x	x	x	x	x	+	+	x	+	x	x	x	x	x
<b>BSO/180/x</b>	x	x	x	x	x	x	+	+	x	+	x	x	x	x	x
<b>BSO/205/x</b>	x	x	x	x	x	x	+	+	x	+	x	x	x	x	x

S - Oklejane folią dekoracyjną | mit Dekorfolie furniert | Decorative foil | Polep dekorativní folií

<sup>1)</sup> wyłącznie w systemie SKO-P | nur im SKO-P system | only in SKO-P system | pouze v systému SKO-P

## BOW

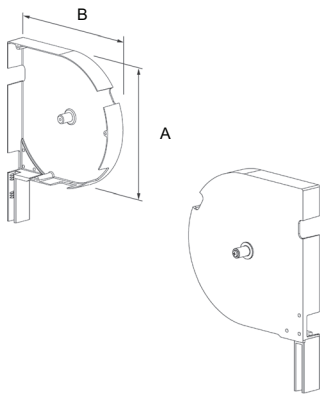

**Bok skrzynki owalnej wewnętrzny - stopka typ I**  
**Rund-Innenblendenkappen - Bolzen Typ I**  
**Internal round end cap - pin type I**  
**Bok oválného boxu vnitřní - patka typu I**

Pakowanie: para | Packung: Paar | Packing: pair | Balení: pár

	A	B	
<b>BOW/137/x</b>	137	142	1
<b>BOW/150/x<sup>1)</sup></b>	150	155	1
<b>BOW/165/x</b>	165	170	1
<b>BOW/180/x</b>	180	185	1
<b>BOW/205/x</b>	205	210	1

**x** Kolor | Farbe | Colour | Barva

**00** nielakierowany | unlackiert | mill finish | nelakovaná

<sup>1)</sup> wyłącznie w systemie SKO-P | nur im SKO-P system | only in SKO-P system | pouze v systému SKO-P

Systemy SKO / SKO-P

## BOWZ

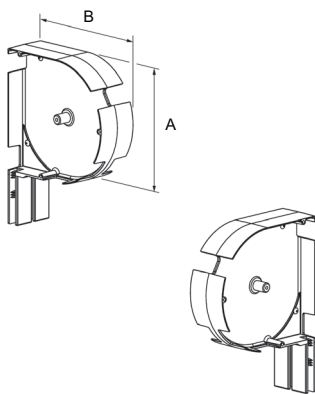

**Boki skrzynki owalnej, wewnętrzne zespolone - stopka typ I**  
**Zusammengesetzte-Rund-Innenblendenkappen - Bolzen Typ I**  
**Compound internal round end caps - pin type I**  
**Boky oválného boxu, vnitřně spojené - patka typu I**

Pakowanie: szt. | Packung: St. | Packing: pcs | Balení: ks

	A	B	
<b>BOWZ/137/x</b>	137	142	1
<b>BOWZ/150/x<sup>1)</sup></b>	150	155	1
<b>BOWZ/165/x</b>	165	170	1
<b>BOWZ/180/x</b>	180	185	1
<b>BOWZ/205/x</b>	205	210	1

**x** Kolor | Farbe | Colour | Barva

**00** nielakierowany | unlackiert | mill finish | nelakovaná

<sup>1)</sup> wyłącznie w systemie SKO-P | nur im SKO-P system | only in SKO-P system | pouze v systému SKO-P

Systemy SKO / SKO-P / SAR

## BOWN

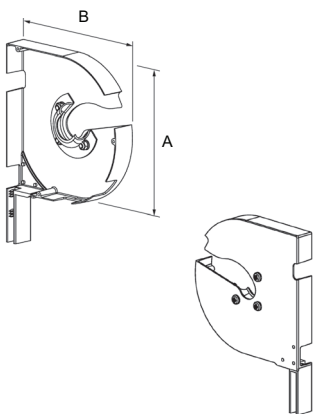

**Bok skrzynki owalnej wewnętrzny, wspólny napęd - stopka typ I**  
**Rund-Innenblendenkappen, gemeinsamer Antrieb - Bolzen Typ I**  
**Internal round end cap, common drive - pin type I**  
**Bok oválného boxu vnitřní, společný pohon - patka typu I**

Pakowanie: para | Packung: Paar | Packing: pair | Balení: pár

	A	B	
<b>BOWN/150/x<sup>1)</sup></b>	150	155	1
<b>BOWN/165/x</b>	165	170	1
<b>BOWN/180/x</b>	180	185	1
<b>BOWN/205/x</b>	205	210	1

**x** Kolor | Farbe | Colour | Barva

**00** nielakierowany | unlackiert | mill finish | nelakovaná

<sup>1)</sup> wyłącznie w systemie SKO-P | nur im SKO-P system | only in SKO-P system | pouze v systému SKO-P

Systemy SKO / SKO-P

## BS 90

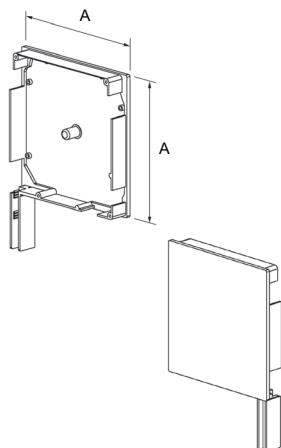

### Pokrywa boczna skrzynki 90° - stopka typ I

Blendenkappen 90° - Bolzen Typ I

End cap 90° - pin type I

Boční kryt boxu 90° - patka typu I

Pakowanie: para | Packung: Paar | Packing: pair | Balení: pár

	A	
<b>BS90/137/x</b>	138	25
<b>BS90/150/x</b>	151	25
<b>BS90/165/x</b>	166	25
<b>BS90/180/x</b>	181	25
<b>BS90/205/x</b>	206	25

**x** Kolor | Farbe | Colour | Barva

**00** nielakierowany | unlackiert | mill finish | nelakovaná

Systemy SP-E / SAR

## BSW 90

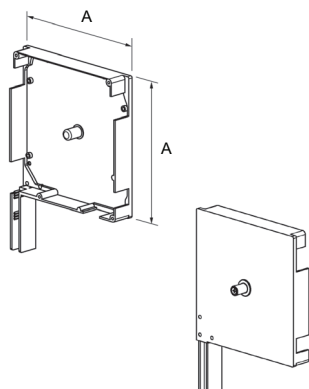

### Bok skrzynki 90° wewnętrzny - stopka typ I

Innenblendenkappen 90° - Bolzen Typ I

Internal end cap 90° - pin type I

Bok boxu 90° vnitřní - patka typu I

Pakowanie: para | Packung: Paar | Packing: pair | Balení: pár

	A	
<b>BSW90/137/x</b>	135	1
<b>BSW90/150/x</b>	148	1
<b>BSW90/165/x</b>	162	1
<b>BSW90/180/x</b>	178	1
<b>BSW90/205/x</b>	203	1

**x** Kolor | Farbe | Colour | Barva

**00** nielakierowany | unlackiert | mill finish | nelakovaná

System SP-E

## BSWZ 90

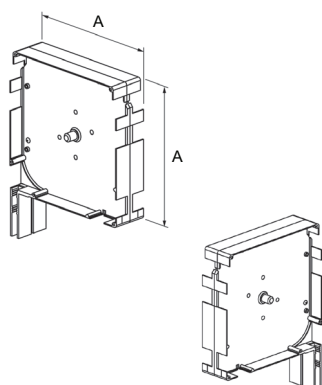

### Boki skrzynki 90°, wewnętrzne zespolone - stopka typ I

Zusammengesetzte Innenblendenkappen 90° - Bolzen Typ I

Compound internal end caps 90° - pin type I

Boky boxu 90°, vnitřně spojené - patka typu I

Pakowanie: szt. | Packung: St. | Packing: pcs | Balení: ks

	A	
<b>BSWZ90/137/x</b>	135	1
<b>BSWZ90/150/x</b>	148	1
<b>BSWZ90/165/x</b>	162	1
<b>BSWZ90/180/x</b>	178	1
<b>BSWZ90/205/x</b>	203	1

**x** Kolor | Farbe | Colour | Barva

**00** nielakierowany | unlackiert | mill finish | nelakovaná

Systemy SP-E / SAR

## SK / G

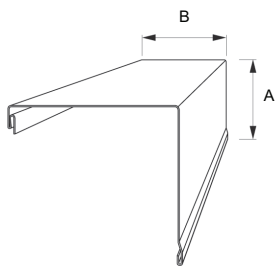

**Skrzynka bramowa - góra**  
**Garagentorkasten - Oberteil**  
**Shutter box for gates - top**  
**Box vrat - horní strana**

Pakowanie: szt. x m | Packung: St. x m | Packing: pcs. x m | Balení: ks x m

	A	B	
<b>SK/G/250/x</b>	255	250	5x4/6
<b>SK/G/300/x</b>	306	300	5x4/6

x	Kolor   Farbe   Colour   Barva
<b>01</b>	srebrny   silber   silver   stříbrná
<b>02</b>	biały   weiß   white   bílá
<b>03</b>	szary   grau   grey   šedá
<b>08</b>	ciemnobrązowy   dunkelbraun   dark brown   tmavě hnědá
<b>09</b>	brązowy   braun   brown   hnědá
<b>23</b>	szary antracyt   anthrazitgrau   anthracite grey   antracitová šedá
<b>NEW 28</b>	orzech   nuss   nut   ořech
<b>NEW 30</b>	złoty dąb   goldeiche   golden oak   zlatý dub

	01	02	03	08	09	23	28	30
<b>SK/G/250/x</b>	x	x	x	x	x	x		
<b>SK/G/300/x</b>	x	x	x	x	x	x	+	+

Systemy BGR / BKR

## SK 45 / D

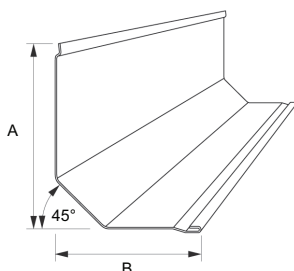

**Skrzynka bramowa 45° - dół**  
**Garagentorkasten 45° - Unterteil**  
**Shutter box for gates 45° - base**  
**Box vrat 45° - spodní strana**

Pakowanie: szt. x m | Packung: St. x m | Packing: pcs. x m | Balení: ks x m

	A	B	
<b>SK45/D/250/x</b>	240	208	5x4/6
<b>SK45/D/300/x</b>	290	250	5x4/6
<b>SK45/D/350/x</b>	350	305	5x4/6

x	Kolor   Farbe   Colour   Barva
<b>01</b>	srebrny   silber   silver   stříbrná
<b>02</b>	biały   weiß   white   bílá
<b>03</b>	szary   grau   grey   šedá
<b>08</b>	ciemnobrązowy   dunkelbraun   dark brown   tmavě hnědá
<b>09</b>	brązowy   braun   brown   hnědá
<b>23</b>	szary antracyt   anthrazitgrau   anthracite grey   antracitová šedá
<b>NEW 28</b>	orzech   nuss   nut   ořech
<b>NEW 30</b>	złoty dąb   goldeiche   golden oak   zlatý dub

	01	02	03	08	09	23	28	30
<b>SK45/D/250/x</b>	x	x	x	x	x	x		
<b>SK45/D/300/x</b>	x	x	x	x	x	x	+	+
<b>SK45/D/350/x</b>	x	x	x	x	x	x		

Systemy BGR / BKR

## SK / G / 350

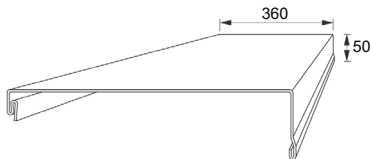

**Skrzynka bramowa - góra**  
**Garagentorkasten - Oberteil**  
**Shutter box for gates - top**  
**Box vrat - horní strana**

Pakowanie: szt. x m | Packung: St. x m | Packing: pcs. x m | Balení: ks x m

- SK/G/350/x**
- stosowana z SK 45/D/350 oraz SK/T/350
  - verwendet mit SK 45/D/350 und SK/T/350
  - used with SK 45/D/350 and SK/T/350
  - používáno s SK 45/D/350 a SK/T/350

x	Kolor   Farbe   Colour   Barva	
01	srebrny   silber   silver   stříbrná	5x4/6
02	biały   weiß   white   bílá	5x4/6
03	szary   grau   grey   šedá	5x4/6
08	ciemnobrązowy   dunkelbraun   dark brown   tmavě hnědá	5x4/6
09	brązowy   braun   brown   hnědá	5x4/6
23	szary antracyt   anthrazitgrau   anthracite grey   antracitová šedá	5x4/6

### Systemy BGR / BKR

## SK / T / 350

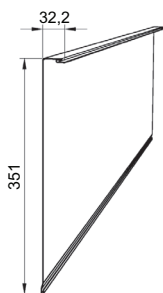

**Skrzynka bramowa - tył**  
**Garagentorkasten - Hinterteil**  
**Shutter box for gates - back part**  
**Box vrat - zadní strana**

Pakowanie: szt. x m | Packung: St. x m | Packing: pcs. x m | Balení: ks x m

- SK/T/350/x**
- stosowana z SK/G/350 oraz SK 45/D/350
  - verwendet mit SK/G/350 und SK 45/D/350
  - used with SK/G/350 and SK 45/D/350
  - používáno s SK/G/350 a SK 45/D/350

x	Kolor   Farbe   Colour   Barva	
01	srebrny   silber   silver   stříbrná	5x4/6
02	biały   weiß   white   bílá	5x4/6
03	szary   grau   grey   šedá	5x4/6
08	ciemnobrązowy   dunkelbraun   dark brown   tmavě hnědá	5x4/6
09	brązowy   braun   brown   hnědá	5x4/6
23	szary antracyt   anthrazitgrau   anthracite grey   antracitová šedá	5x4/6

### Systemy BGR / BKR

## SKO-P / G

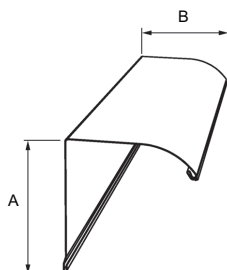

**Skrzynka bramowa systemu Owal - góra**  
**Garagentorkasten des OWAL-Systems - Oberteil**  
**Garage shutter box Oval system - top**  
**Box vrat systému OWAL - horní strana**

Pakowanie: szt. x m | Packung: St. x m | Packing: pcs. x m | Balení: ks x m

	A	B	
<b>SKO-P/G/230/x</b>	228	216	5x4/6
<b>SKO-P/G/250/x</b>	250	240	5x4/6
<b>SKO-P/G/300/x</b>	300	286	5x4/6

x	Kolor   Farbe   Colour   Barva
02	biały   weiß   white   bílá
99	lakier podkładowy   Unterschicht-Lack   primer   podkladový lak

### Systemy BGR / BKR



## SKO-P / D

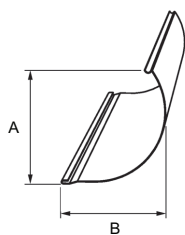

**Skrzynka bramowa systemu Owal - dół**  
**Garagentorkasten des OWAL-Systems - Unterteil**  
**Garage shutter box Owal system - base**  
**Box vrat systému OWAL - spodní strana**

Pakowanie: szt. x m | Packung: St. x m | Packing: pcs. x m | Balení: ks x m

	A	B	
<b>SKO-P/D/230/x</b>	185	199	5x4/6
<b>SKO-P/D/250/x</b>	197	217	5x4/6
<b>SKO-P/D/300/x</b>	235	261	5x4/6

**x Kolor | Farbe | Colour | Barva**

**02** biały | weiß | white | bílá

**99** lakier podkładowy | Unterschicht-Lack | primer | podkladový lak

Systemy BGR / BKR

## BS 45

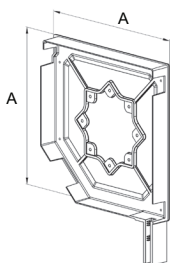

**Pokrywa boczna skrzynki 45° - stopka typ II**  
**Blendenkappen 45° - Bolzen Typ II**  
**End cap 45° - pin type II**  
**Boční kryt boxu 45° - patka typu II**

Pakowanie: para | Packung: Paar | Packing: pair | Balení: pár

	A	
<b>BS45/250/x</b>	252	6
<b>BS45/300/x</b>	302	6

**x Kolor | Farbe | Colour | Barva**

**00** nielakierowany | unlackiert | mill finish | nelakovaná

**01** srebrny | silber | silver | stříbrná

**02** biały | weiß | white | bílá

**03** szary | grau | grey | šedá

**08** ciemnobrązowy | dunkelbraun | dark brown | tmavě hnědá

**09** brązowy | braun | brown | hnědá

**23** szary antracyt | anthrazitgrau | anthracite grey | antracitová šedá

**NEW 28** orzech | nuss | nut | ořech

**NEW 30** złoty dąb | goldeiche | golden oak | zlatý dub

	00	01	02	03	08	09	23	28	30
<b>BS45/250/x</b>	x	x	x	x	x	x	x		
<b>BS45/300/x</b>	x	x	x	x	x	x	x	+	+

Systemy BGR / BKR

## BS 45 / K / 350

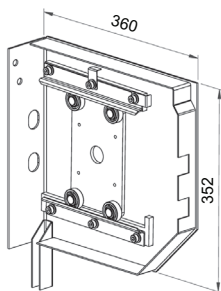

**Pokrywa boczna skrzynki 45° z konsolą - stopka typ II**  
**Blendenkappen 45° mit Konsole - Bolzen Typ II**  
**End cap 45° with console - pin type II**  
**Boční kryt boxu 45° s konzolou - patka typu II**

Pakowanie: para | Packung: Paar | Packing: pair | Balení: pár

- BS45/K/350/x**
- do kraty oraz bramy garażowej
  - für Gitter und Garagentore
  - for grills and garage door
  - k mřížím a garážovým vratům

x	Kolor   Farbe   Colour   Barva	
00	nie lakierowany   unlackiert   mill finish   nelakovaná	1
01	srebrny   silber   silver   stříbrná	1
02	biały   weiß   white   bílá	1
03	szary   grau   grey   šedá	1
08	ciemnobrązowy   dunkelbraun   dark brown   tmavě hnědá	1
09	brązowy   braun   brown   hnědá	1
23	szary antracyt   anthrazitgrau   anthracite grey   antracitová šedá	1

### Systemy BGR / BKR

## BSO

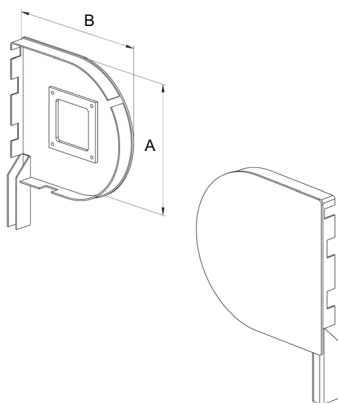

**Pokrywa boczna skrzynki owalnej - stopka typ II**  
**Rund-Blendenkappen - Bolzen Typ II**  
**Round end cap - pin type II**  
**Boční kryt oválného boxu - patka typu II**

Pakowanie: para | Packung: Paar | Packing: pair | Balení: pár

	A	B	
<b>BSO/230/x</b>	230	240	6
<b>BSO/250/x</b>	252	262	6
<b>BSO/300/x</b>	302	312	6

x	Kolor   Farbe   Colour   Barva
00	nie lakierowany   unlackiert   mill finish   nelakovaná
02	biały   weiß   white   bílá

### Systemy BGR / BKR

## KBS 45

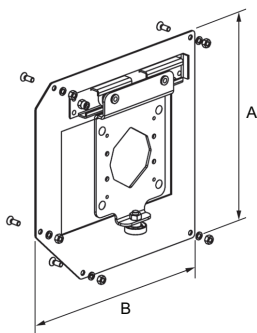

**Konsola do pokryw bocznych**  
**Konsole für Blendenkappen**  
**Consoles for end caps**  
**Konzola k bočním krytům**

Pakowanie: para | Packung: Paar | Packing: pair | Balení: pár

- KBS45/250**
- ocynkowana, stosowana z pokrywami bocznymi BS 45/250
  - verzinkt, verwendet mit den Blendenkappen BS 45/250
  - galvanized, used with end caps BS 45/250
  - pozinkováno, používáno s bočními kryty BS 45/250
- KBS45/300**
- ocynkowana, stosowana z pokrywami bocznymi BS 45/300
  - verzinkt, verwendet mit den Blendenkappen BS 45/300
  - galvanized, used with end caps BS 45/300
  - pozinkováno, používáno s bočními kryty BS 45/300

	A	B	
<b>KBS45/250</b>	237	238	1
<b>KBS45/300</b>	287	288	1

### Systemy BGR / BKR

## KNB

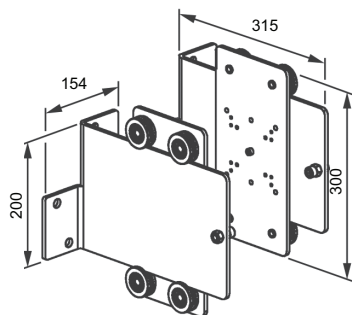

### Konsola Konsole Console Konzola

Pakowanie: 1 para | Packung: 1 Paar | Packing: 1 pair | Balení: 1 pár

#### KNB

- ocynkowana, do kraty oraz bramy garażowej. Max obciążenie konsoli 250 kg.
- verzinkt, für Rollgitter und Garagenrolltore. Die Maximale Belastung für die Konsole ist 250 kg.
- galvanized, for grille and garage door. The maximum load of the konsole is 250 kg.
- pozinkováno, k mříži a garážovým vratům. Maximální zatížení konzolí - 250 kg

Systemy BGR / BKR

## LS

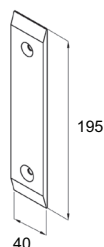

### Listwa ślizgowa Gleitplatte Slide slat Kluzná lišta

Pakowanie: 1 szt. | Packung: 1 St. | Packing: 1 pcs | Balení: 1 ks

#### LS

- stosowana z KNB, KBS 45, BS 45 / K / 350, KNJ
- verwendet mit KNB, KBS 45, BS 45 / K / 350, KNJ
- used with KNB, KBS 45, BS 45 / K / 350, KNJ
- používáno s KNB, KBS 45, BS 45 / K / 350, KNJ

Systemy BGR / BKR / BPR

## WPB

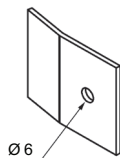

### Wspornik do montażu pokryw bocznych Montageplatte für Blendenkappen Plate for end caps Podpěra pro montáž bočních krytů

Pakowanie: 1 szt. | Packung: 1 St. | Packing: 1 pcs | Balení: 1 ks

#### WPB

- do montażu pokryw bocznych: BS\_45, BS 45, BSP, BSO, BS 90
- für die Montage der Blendenkappen: BS\_45, BS 45, BSP, BSO, BS 90
- for end caps installation: BS\_45, BS 45, BSP, BSO, BS 90
- k montáži bočních krytů: BS\_45, BS 45, BSP, BSO, BS 90

Systemy BGR / BKR